



HLA Heatless Purge

Desiccant Compressed Air Dryer 90-5,000 SCFM



Installation, Operation, and Maintenance Manual

**PORTLAND
COMPRESSOR**
Experience You Can Depend On
800-542-8300



Save These Instructions



CONTENTS

1.0 INTRODUCTION	3	8.0 INSTALLATION AND START-UP	26
2.0 ABBREVIATED WARRANTY	3	8.1 APPLICATION AND CHECK ANALYSIS	26
3.0 NOMENCLATURE	4	8.2 LOCATING AND MOUNTING	26
4.0 RECEIVING AND INSPECTION	4	8.3 PIPING	26
4.1 INSPECTION	4	8.4 FILTRATION.....	26
4.2 UNPACKING AND HANDLING	4	8.4.1 FILTER DRAIN VALVE	27
5.0 SAFETY AND OPERATION PRECAUTIONS	5	8.5 ELECTRICAL CONNECTION	28
5.1 SAFETY PRECAUTIONS LIST.....	5	8.6 DESICCANT LEVEL VERIFICATION	28
6.0 PRINCIPLES OF OPERATION	6	8.7 DEW POINT MONITOR (EMS OPTION).....	28
6.1 INTRODUCTION	6	8.8 START-UP PROCEDURE	28
6.2 DRYING CYCLE	6	8.9 DRYER SHUT-DOWN SEQUENCE	30
6.3 REGENERATION CYCLE.....	6	9.0 MAINTENANCE AND SYSTEM CHECK	31
6.4 SETTING THE REGENERATION AIR FLOW	6	9.1 SCHEDULED MAINTENANCE.....	31
6.5 TOWER RE-PRESSURIZATION.....	7	9.2 PREFILTERS AND AFTERFILTERS.....	31
6.6 VALVES	7	9.3 PILOT AIR CONTROL SOLENOID VALVES AND FILTER/ REGULATOR.....	32
6.7 TIMING SEQUENCE	7	9.4 MUFFLER CHANGEOUT PROCEDURE.....	32
6.8 COMPRESSOR INTERLOCK FUNCTION.....	7	9.5 ANGLE SEATED PURGE AND SWITCHING VALVES.....	32
6.9 DRYER CONTROLS	8	9.6 OUTLET CHECK VALVES.....	32
6.9.1 OPERATING THE DIGITAL CONTROLLER.....	8	9.7 DESICCANT CHANGEOUT PROCEDURE	33
6.9.2 DIGITAL DRYER CONTROLLER DISPLAY PARAMETERS	9	10.0 TROUBLESHOOTING	35
6.9.2.1 TOWER STATUS INDICATION LEGEND	9	11.0 PURGE CHARTS	36
6.9.3 HOME.....	10	12.0 GENERAL ARRANGEMENT	40
6.9.4 TECHNICIAN MODE	10	13.0 WIRING DIAGRAM	52
6.9.5 ALARM INDICATION/EVENT LOGGING.....	14	14.0 FLOW DIAGRAM	54
6.9.6 MAINTENANCE ALERTS	15	15.0 REPLACEMENT PARTS	58
6.9.7 GENERAL SETTINGS.....	16	HIGH PERFORMANCE BUTTERFLY VALVE DETAIL VIEWS.....	64
6.9.8 COMMUNICATIONS	18	16.0 ENGINEERING SPECIFICATIONS	66
6.9.9 OPERATING STATUS	20		
7.0 ALARMS AND INDICATORS	22		
7.1 MOISTURE INDICATOR.....	22		
7.2 FAIL-TO-SHIFT AND TOWER PRESSURE ALARM MONITORING	22		
7.3 ENERGY MANAGEMENT SYSTEM	22		
7.4 CONTROLLER ALARM / WARNING / MAINTENANCE ALERT SUMMARY	23		

1.0 INTRODUCTION

Ingersoll Rand HLA Heatless Desiccant Dryers are designed to adsorb moisture from compressed air. The dryers are constructed with two towers, each containing desiccant beads, that alternate between online (drying) and offline (regenerating) modes, yielding a continuous stream of dry air at the dryer's outlet.

During normal operation, wet air passes through the online tower and water vapor from the air is adsorbed (collected) on the desiccant beads. While air is being adsorbed in the online tower, the moisture on the desiccant in the offline tower is removed by a process called desorption (regeneration). After an initial rapid depressurization, a portion of dried air from

the online tower passes over the desiccant bed and carries the moisture off the bed and out the dryer's exhaust.

The continuous, alternating process of adsorption and desorption is controlled using a timer that switches the towers in a specific timed sequence. Very dry compressed air dew points are achieved through the continuous switching and operation of this dryer. **Ingersoll Rand** offers dryers to provide either -40°F (-40 °C) or -100°F (-73,33 °C) pressure dew point outlet air.

2.0 ABBREVIATED WARRANTY

Ingersoll Rand heatless desiccant dryer products are warranted to be free from defects in material and workmanship for a period of 12 months from the original date of shipment from the factory. To allow the warranty to be in effect for 12 months from the date of equipment start-up, the Warranty Registration Card must be completed and returned to **Ingersoll Rand**. Alternately, the Warranty Registration Card may be completed online at www.Ingersoll Rand.com. The total warranty period cannot exceed 18 months from the original date of shipment from the factory.

Equipment must be installed and operated in accordance with **Ingersoll Rand**'s recommendations. **Ingersoll Rand** liability is limited to repair of, refund of purchase price paid for, or replacement in kind at **Ingersoll Rand**'s sole option,

during the warranty time period stated above. IN NO EVENT SHALL **Ingersoll Rand** BE LIABLE OR RESPONSIBLE FOR INCIDENTAL OR CONSEQUENTIAL DAMAGES, even if the possibility of such incidental or consequential damages has been made known to **Ingersoll Rand**. In addition, the usual maintenance and replacement type products are not covered by this warranty. See SECTION 9.

The warranties expressed above are in lieu of and exclusive of all other warranties. There are no other warranties, expressed or implied, except as stated herein. There are no implied warranties of merchantability or fitness for a particular purpose, which are specifically disclaimed.

3.0 NOMENCLATURE

Type/Design Series	Nominal Flow SCFM*	Voltage (Dew Point)	NEMA	Electrical Option
HLA = Pressure Swing	90	1 = 115-1-60 (-40 °C/-40 °F)	H = NEMA 4	0 = Standard
	120	B = 115-1-60 (-73,33 °C/-100 °F)	S = NEMA 4X	A = Failure-To-Shift (FTS)
	160	2 = 230-1-60 (-40 °C/-40 °F)	Stainless Steel	E = Energy Management System (EMS)
	200	C = 230-1-60 (-73,33 °C/-100 °F)		G = EMS + FTS
	250	3 = 220-1-50 (-40 °C/-40 °F)		
	300	E = 220-1-50 (-73,33 °C/-100 °F)		
	400			
	500			
	600			
	800			
	1,000			
	1,200			
	1,500			
	1,800			
	2,100			
2,700				
3,300				
4,000				
5,000				

* Nominal flows indicated are for 100°F (37,7 °C) inlet temperature, 100°F (37,7 °C) ambient temperature and 100 psig compressed air pressure.

Nominal Flow (SCFM) capacities indicated are for dryer models delivering -40°F dew point air quality. Dryer models delivering -100°F dew point air quality have reduced flow capacity.

NOTICE

Nomenclature shown above represents standard price sheet options. Other options are available - refer to nomenclature insert specific to your dryer for details.

4.0 RECEIVING AND INSPECTION

■ 4.1 INSPECTION

Upon receiving your **Ingersoll Rand** air dryer, inspect the unit closely. If evidence of rough handling is detected, note it on your delivery receipt, especially if the dryer will not be uncrated immediately. Obtaining the delivery person's signed agreement to noted damages will facilitate submission of insurance claims.

Contact your local sales office to obtain a RMA claim to initiate the return process (if required).

■ 4.2 UNPACKING AND HANDLING

NOTICE

Under no circumstances should any person attempt to lift heavy objects without proper lifting equipment (i.e.: crane, hoist, slings or fork truck). Lifting any unit without proper lifting equipment can cause serious injury.

Refer to labels on the dryer for the appropriate means for lifting or moving the dryer. When lifting the dryer, ensure that no stress is applied to the piping or the valves. Refer to SECTION 8.2 for locating and mounting of the dryer.

The dryer can be rigged using the forklift rails that are welded to the upper cross member that spans between the two vessels. Use care when inserting fork lift tongs beneath these rails to avoid damaging piping at the rear of the dryer.

5.0 SAFETY AND OPERATION PRECAUTIONS

■ 5.1 SAFETY PRECAUTIONS LIST

Because an air dryer is pressurized and contains mechanical parts, the same precautions should be observed as with any piece of machinery of this type where carelessness in operation or maintenance is hazardous to personnel. In addition to the many obvious safety rules that should be followed with this type of machinery, the safety precautions as listed below must be observed:

1. Only qualified personnel shall be permitted to adjust, perform maintenance or repair this air dryer.
2. Read all instructions completely before operating unit.
3. Pull main electrical disconnect switch and disconnect any separate control lines, if used, before attempting to work or perform maintenance on the unit. Use proper lockout/tag out Procedures.
4. Do not attempt to service any part while dryer is in an operational mode.
5. When servicing this dryers, do not attempt to remove any parts without first relieving the entire air system of pressure.
6. Do not operate the dryer at pressures in excess of its rating.
7. Inspect unit daily to observe and correct any unsafe operating conditions.
8. Dryer must be de-pressurized before servicing.

OSHA Heading Descriptions

WARNING

“WARNING” is used to indicate a hazardous situation which has some probability of death or severe injury. Warning should not be considered for property damage accidents unless personal injury risk is present.

CAUTION

“CAUTION” is used to indicate a hazardous situation which may result in minor or moderate injury.

NOTICE

“NOTICE” is used to indicate a statement of company policy as the message relates directly or indirectly to the safety of personnel or protection of property. Notice should not be associated directly with a hazard or hazardous situation and must not be used in place of “DANGER,” “WARNING,” or “CAUTION.”

NOTICE

The user of any air dryer manufactured by Ingersoll Rand, is hereby warned that failure to follow the above Safety and Operation Precautions can result in personal injuries or equipment damage. However, Ingersoll Rand does not state as fact, nor does it mean to imply, that the preceding list of Safety and Operation Precautions is all inclusive, and further, that the observance of this list will prevent all personal injuries or equipment damage.



6.0 PRINCIPLES OF OPERATION

6.1 INTRODUCTION

As described in SECTION 1, the HLA series dryer is used to remove water vapor from compressed air by diverting air flow alternately between two towers that are filled with desiccant material. While one tower processes the compressed air stream, adsorbing water vapor, the opposite tower is regenerated by desorbing the water vapor accumulated in the previous cycle and venting it to atmosphere. Refer to SECTION 14, FLOW DIAGRAM for a visual representation of the drying and regenerating cycles.

Inlet flow to the dryer is directed to the bottom manifold and the outlet flow exits through the upper manifold. The manifolds are comprised of both pneumatically actuated valves and check valves that direct compressed air flow through the dryer.

6.2 DRYING CYCLE

Saturated compressed air enters the dryer and is directed to the appropriate drying tower by the corresponding inlet flow valves. The inlet flow valves are normally-open and one of the valves will be actuated closed to direct the flow of compressed air to the designated drying tower. It is important to note that only one inlet valve is closed during this process. The FLOW DIAGRAM in SECTION 14 of this Technical Manual depicts the scenario where the left tower is being regenerated and the drying process is occurring with the right tower. In this example, wet compressed air enters the dryer and is directed to the right tower for drying when the left tower, normally-open flow valve is actuated to a closed position. The normally-closed, right tower purge valve is closed while the left tower purge valve is actuated to an open position during this period. As the compressed air flows through the desiccant material on the right tower, removal of water vapor from the air stream begins to occur through adsorption.

6.3 REGENERATION CYCLE

Previously adsorbed moisture, removed from the process stream, gets stripped or desorbed from the desiccant material in the regeneration process. The first stage of regeneration is tower depressurization. After the normally-open Inlet Flow Valves are switched to divert air flow away from the regenerating tower, the appropriate normally-closed Purge Valve will be opened and the tower will be depressurized. Through rapid depressurization, a significant portion of the previously adsorbed water vapor is stripped off of the desiccant material and exhausted to atmosphere.

The second stage of regeneration uses a portion of the dry, compressed air, expanded to atmospheric pressure to complete the desorption process. As depicted in the FLOW DIAGRAM, the compressed air exits the drying tower and a portion of the air flows through the Purge Adjustment Valve and the Purge Orifice. Once the air has passed through the Purge Orifice, it expands to atmospheric pressure and continues the regeneration process. Desorption occurs as the desiccant releases water vapor into the regeneration air that is then exhausted through the Purge Muffler.

HLA Heatless Dryers are equipped with a Downstream Purge feature as standard. The Downstream Purge utilizes air from a downstream source to purge the regenerating tower. This feature is useful for applications with downstream (dry) storage tanks, as pulling air from a downstream source can minimize cycling of the air compressor.

6.4 SETTING THE REGENERATION AIR FLOW

To enable the desiccant media within the towers to be thoroughly regenerated and to get proper dryer performance, it's necessary to manually set the purge air flow. Setting the purge flow too high will waste compressed air and if set too low, the dryer will not achieve proper dew point performance.

The purge flow must be set when the left tower is operating as the drying tower (pressurized) and the right tower is being regenerated (de-pressurized).

NOTICE

When setting purge flow, the left tower must be the drying tower for proper purge adjustment setting. When the right tower is the drying tower, the Purge Adjustment Gauge will read close to line pressure.

The purge adjustment manifold consists of the Purge Adjustment Valve, the Purge Pressure Gauge and the Purge Orifice. When the left tower is the drying tower (pressurized) and the right tower is depressurized (less than 7 PSIG), manually adjust the Purge Adjustment Valve until the gauge reading on the purge pressure gauge matches the Purge Pressure Gauge setting listed on the laminated tag that's affixed to the Orifice Plate Assembly. SECTION 11 of this Technical Manual also includes the proper Purge Pressure Gauge setting value.

NOTICE

When using the Energy Management System (EMS) feature, the purge valve MUST be adjusted to the factory set point to ensure proper operation of these features.

NOTICE

Do not restrict purge exhaust flow in any way. Keep purge mufflers clean. If exhaust air must be piped away from dryer, consult factory for correct pipe sizing and configuration.

6.5 TOWER RE-PRESSURIZATION

Upon completion of tower regeneration, and prior to the Inlet Flow Valves changing position to switch towers, the regenerated tower must be repressurized.

NOTICE

Failure to re-pressurize prior to tower switch-over will result in shocking the desiccant material and cause premature desiccant dusting.

Re-pressurization is accomplished when the appropriate Purge Valve closes. Closing the Purge Valve allows the regeneration air to begin to pressurize the tower. In addition to the regeneration air, the repressurization Valve, (standard on -100°F (37,7 °C) dew point and high pressure dryers; optional on -40°F (-40 °C) dew point dryers) opens allowing some additional air from the outlet of the dryer to ensure adequate pressurization. This valve is pneumatically operated.

■ 6.6 VALVES

Control Air Solenoid Valves are used to actuate the Main Flow Valves and Purge Valves. The Inlet Flow Valves and the optional repressurization Valve are normally-open valves, while the Purge Valves are normally-closed valves. This arrangement permits air to flow through the dryer in the event of power failure. The Control Air Solenoid Valves are located below the main Control Box.

Outlet Check Valves are single direction check valves that will allow flow in the direction shown on the P&ID, but not allow flow in the opposite direction.

■ 6.7 TIMING SEQUENCE

A Digital Controller controls all dryer timing functions. Regardless of controller, the timing of **Ingersoll Rand** -40°F (-40 °C) and -100°F (37,7 °C) dryers is outlined as follows:

6.7.1 TIMING CYCLE FOR -40°F (-40 °C) DEW POINT DRYERS

The standard timing cycle for -40°F (-40 °C) operation switches the Inlet Flow Valve position every five minutes which alternates the drying tower. At the same time as a tower Inlet Valve opens, the appropriate tower Purge Valve opens to depressurize the regenerating tower. Tower regeneration occurs for 4 minutes and 15 seconds, at which time the Purge Valve closes to initiate repressurization.

6.7.2 TIMING CYCLE FOR -100°F (37,7 °C) DEW POINT DRYERS

The standard timing cycle for -100°F (37,7 °C) operation switches the Inlet Flow Valve position every 2 minutes which alternates the drying tower. At the same time a tower Inlet Valve opens, the appropriate tower Purge Valve opens to depressurize the regenerating tower. Tower regeneration occurs for 1 minute and 50 seconds, at which time the Purge Valve closes to initiate repressurization. The repressurization Valve opens to assist tower re-pressurization for the last 10 seconds prior to Inlet Flow Valve switching.

The re-pressurization valve is pneumatically operated by a shuttle valve. For -100°F (37,7 °C) applications, the timing cycle can be adjusted from -100°F (37,7 °C) to -40°F (-40 °C) or +4°F (-15,55 °C) by entering TECHNICIAN MODE, Screen 6/12, when the dryer cycle is turned off.

■ 6.8 COMPRESSOR INTERLOCK FUNCTION

The Compressor Interlock function enables the dryer to reduce the timing of the purge cycle based on compressed air demand. When the function is activated through the TECHNICIAN MODE within the Digital Controller, the Controller will monitor the cycle rate of the air compressor load / unload relay. The dryer will need to be field wired to the normally-open contact of the air compressor to allow the controller to monitor the cycle rate. The compressor interlock connections are depicted on the dryer wiring diagram.

It is important to note that the Compressor Interlock function is designed to be operated independent of the Energy Management System (EMS) option. For dryers equipped with the EMS option, the Compressor Interlock must be set to "OFF" in order to activate the EMS function. Setting the Compressor Interlock to "ON" in TECHNICIAN MODE will disable the EMS function.

For dryers equipped with the EMS option, the Compressor Interlock function can be used as a backup method to reduce purge air consumption when the Dew Point Monitor is removed for calibration or for service. It is important to note that the performance of the dryer is based on the inlet temperature and pressure conditions along with flow. If the inlet temperature of the compressed air being supplied to the dryer is above 100°F, the user must exercise caution in order to prevent the desiccant beds from becoming overloaded, possibly requiring the Compressor Interlock function to be de-activated. Consult factory for higher inlet temperatures (38,33 °C/101 °F - 48,9 °C/120 °F). Dryer sizing is affected by increased inlet temperatures.

When the dryer is placed into operation and the compressor interlock function is activated, the Digital Controller will monitor the cycle rate of the air compressor load / unload relay contact over a fixed time period to determine the Load Time Average (LTA) percentage. The time period can be adjusted from 30-90 minutes by accessing SCREEN 12 in TECHNICIAN MODE. The purge timing cycle will be adjusted by the Controller at the completion of the initial time interval. The table below outlines the purge time reduction based on the Load Time Average values:

Purge Cycle Time Reduction

Load Time Average, LTA %	Purge Time Reduction Percentage
Greater than 90%	0%
70% - 89%	10%
50% - 69%	25%
30% - 49%	40%
0% - 29%	65%

It is important to verify that the field wiring connections are properly installed during commissioning of the dryer in order to prevent operational issues. If the compressor interlock wiring is not installed, the Compressor Interlock function must be set to "OFF" within TECHNICIAN MODE in order to prevent operational problems. In the event that this were to occur, the dryer would operate with a reduced purge timing cycle that will result in desiccant overloading and failure that would void the dryer Warranty.

■ 6.9 DRYER CONTROLS

The dryer is controlled by a Digital Controller that includes an illuminated display and keypad, accessible on the dryer Main Panel.

■ 6.9.1 OPERATING THE DIGITAL CONTROLLER

The illustration shown below summarizes the Controller keypad functions included with the NEMA 4/Digital Controller option.

When power is first applied to the dryer, this microprocessor controller will illuminate and briefly display an INITIALIZATION SCREEN before changing to the default HOME SCREEN. From this screen the user can navigate to start, stop, monitor or alter the dryer Operating Cycle and test dryer functions.

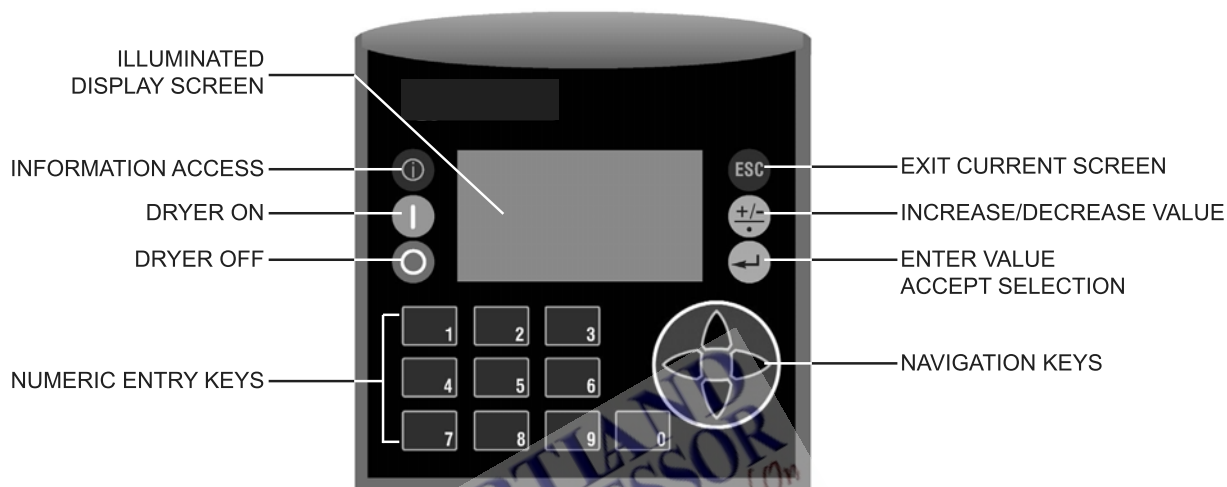

CONTROLLER BUTTONS AND KEYS

- **INFORMATION BUTTON**

Restricted Level access - for factory use only.

- **ON/RESUME BUTTON**

Initiates Dryer Operating Cycle. Begins system monitoring and valve switching functions.

- **OFF BUTTON**

Stops Dryer Operating Cycle. Stops valve switching functions. Initiates Shutdown Sequence. Dryer remains pressurized. Hold for 5 seconds for OFF function. When the Remote START/STOP function is activated in TECHNICIAN MODE, the OFF Button is disabled and the dryer ON/OFF operation will be controlled the customer DCS Relay output.

- **NUMERAL KEYS**

Allow the operator to enter values for selectable settings and assignments.

- **ESC BUTTON**

Exit current screen.

- **+/- BUTTON**

Used to toggle or change multistate variables. Also allows entering negative numbers in numeric input variables.

- **ENTER BUTTON**

Used to change and accept set point values.

- **NAVIGATION KEYS (ARROWS)**

Enables navigation between screens and lines.





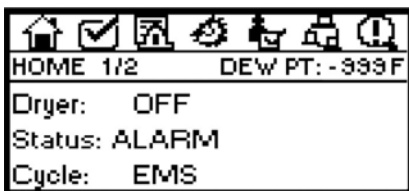

Menu Icons are located at the top of the display screen. Press the RIGHT or LEFT Navigation Keys to scroll through the Icons. The selected Icon will be highlighted (darken) when active.

Multiple SCREENS can be viewed within each Icon. Use the UP and DOWN Navigation Keys to navigate within each Icon. The second row of the display indicates which SCREEN is visible.



■ 6.9.2 DIGITAL DRYER CONTROLLER DISPLAY PARAMETERS

The controller display is a graphical interface that allows user access to information and settings through use of the UP/DOWN/RIGHT/LEFT Navigation Keys. Information is organized under Menu Icons as listed below:

ICON	DISPLAY PARAMETERS	DESCRIPTION
	HOME	Display of dryer status, program sequence information, alarm status and drain test information.
	TECHNICIAN MODE	Location to adjust/change dryer operation settings. Password is required to access.
	ALARM INDICATION/EVENT LOGGING	View historical information related to alarms, power up condition.
	MAINTENANCE ALERTS	General reminders to replace filter elements, inspect drains and others.
	GENERAL SETTINGS	Time & Date; Language (English is default); Backup solenoid drain adjustment. EMS adjustment (optional)
	COMMUNICATIONS	Establish remote communication settings.
	STATUS	Displays information related to sensors, valve activation, drain status, etc.

NOTE: The display will revert to the HOME SCREEN following any period of inactivity.

PARAMETER CHANGE INSTRUCTIONS

To Make Numeric Value Changes:

1. Use UP/DOWN Navigation Keys to highlight the value that needs to be changed.
2. Press ENTER Button and enter a revised value using numeric entry keys.
3. Press ENTER Button again to save the new value. The Dryer Operating Program will then use the new value.

TEXT VALUE CHANGES OR TEST BUTTON CHANGES:

1. Use UP/DOWN Navigation Keys to highlight the value that needs to be changed.
2. Press the +/- button to change the value to the new setting.

■ 6.9.2.1 TOWER STATUS INDICATION LEGEND

LT : Left Tower

RT : Right Tower

DRY : Tower is pressurized and is drying compressed air

REGEN : Tower is depressurized and desiccant bed is being regenerated

VLV CHG : Valve change sequence that directs compressed air and purge air through proper flow paths

REG* : Tower is pressurized without flow. This occurs when the tower designated for regeneration is not required to be depressurized when either, 1) EMS set-point is satisfied and purge air is not required, or 2) Compressor Interlock function is activated and the reduced purge time cycle is completed.

■ 6.9.3 HOME

Display of dryer status, program sequence information, alarm status and drain test information.

• HOME SCREEN 1/2

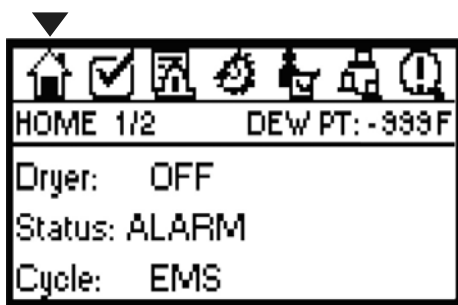

← **DEW PT:** Indication of outlet air quality.

← **Dryer Operation:** Displays "ON", "OFF" or "Shutting Down".

← **Status:** "OK" if no active alarms; "ALARM" if an alert or alarm is triggered.

← **Cycle:** Indicates operation in standard "Timed" cycle or "EMS" cycle.

• HOME SCREEN 2/2



← **Tower Status:** Indication of Left Tower and Right Tower operating status.

← **Step:** Step in operating cycle and time remaining within that Step.

■ 6.9.4 TECHNICIAN MODE

Enables trained users to set parameters for triggering alarms, enable specific operating functions, and troubleshooting (including jogging the sequence and valve output test function).

• TECHNICIAN MODE SCREEN 1/12



← **Enter Password:** This Mode is Password protected.

← **Password:** 2010 (Use Numeral Keys to enter Password).

• **TECHNICIAN MODE SCREEN 2/12**

For values in this screen to be displayed, dryer must be pressurized.



- ← **Tower Status:** Indication of Left Tower and Right Tower operating status.
- ← **Step:** Step in operating cycle and time remaining within that Step.
- ← **Jog Step:** Use +/- key to jog the primary steps in the operating sequence.

• **TECHNICIAN MODE SCREEN 3/12**

Dryer must be turned OFF and system or control air circuit must be pressurized before initiating this function.

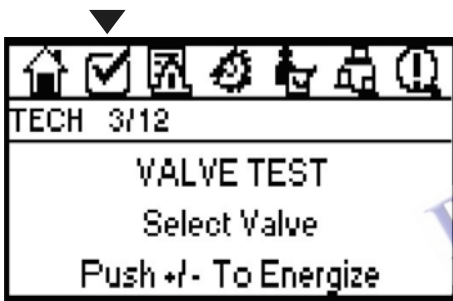

- ← **Valve Test:** Individual valve test function.
- ← **Select Valve:** Choose from four main actuated valves.
- ← **Press +/-:** Use the ▼ (Down) Navigation Key to index through the valves.

• **TECHNICIAN MODE SCREEN 4/12**

Dryer must be turned off and system or control air circuit must be pressurized before initiating this function.

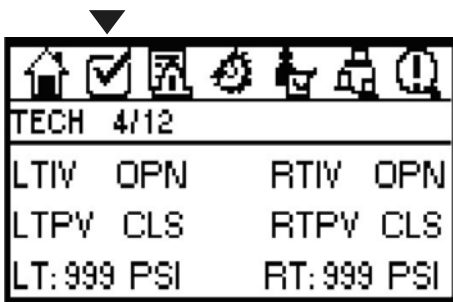

- ← **Select Valve:** Use Navigation Buttons to select individual valves.
 LTIV - Left tower inlet valve RTIV - Right tower inlet valve
 LTPV - Left tower purge valve RTPV - Right tower purge valve
- ← **Press +/-:** Press button to test controller output. Pressure for towers will be displayed on dryers with Fail-To-Shift option.

- **TECHNICIAN MODE SCREEN 5/12**

Dryer must be turned off and system or control air circuit must be pressurized before initiating this function.

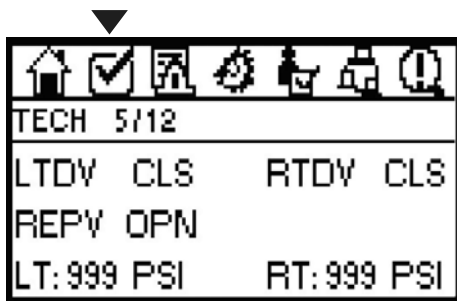

← **Press +/-:** Press key to test controller output. Pressure for towers will be displayed on dryers with Fail-To-Shift option.

- **TECHNICIAN MODE SCREEN 6/12**



← **Operation Mode:** "HL", Heatless.

← **Dew Point Adjust:** Choose "-40" or "-100". *Change timing cycle by pressing +/- key. -100 setting can only be selected when the dryer is equipped with the -100°F (37,7 °C) option. Requires addition of molecular sieve to the desiccant bed in each vessel.

-40°F (-40 °C)-equipped dryers – Can select -40°F (-40 °C) or -4°F Timing Cycle

-100°F (37,7 °C)-equipped dryers – Can select -100°F (37,7 °C), -40°F (-40 °C) or -4°F Timing Cycle

Timing Cycle can only be adjusted when the dryer is off.

← **Press +/-:** Press button to select "ON" or "OFF" for this feature. Compressor Interlock requires the dryer be connected to a normally-open relay contact from the air compressor.

- **TECHNICIAN MODE SCREEN 7/12**

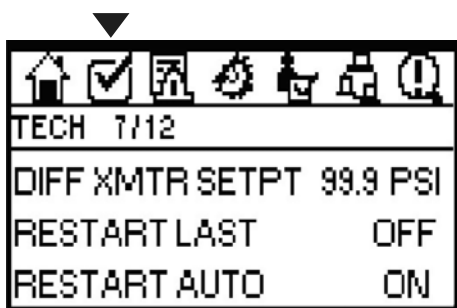

← **Differential Transmitter Setting:** Set point to trigger alarm and alarm relay on dryers equipped with optional inlet and outlet filter transducers.

← **RESTART LAST:** OFF-Dryer will need to be manually restarted following a power outage.

← **RESTART AUTO:** ON-Dryer will automatically restart upon a power outage.

• TECHNICIAN MODE SCREEN 8/12

To be applicable, Dryer must be furnished with optional dew point sensor.

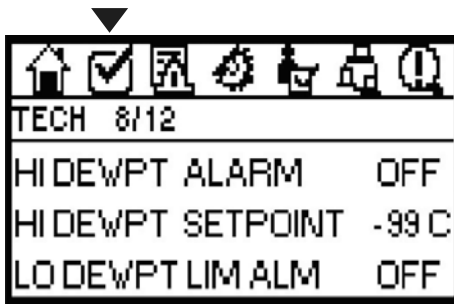

- ← **HI DEWPT ALARM:** Choose "ON" or "OFF". When set to "ON", alarm will trigger when measured value exceeds the high Dew Point setting.
- ← **HI DEWPT SETPOINT:** Value establishes the Alarm trigger point.
- ← **LO DEWPT ALM:** Choose "ON" or "OFF". In certain cases during low flow operation, outlet dew point may fall below the low limit of the sensor. When set to "OFF", the Controller will disregard the Dew Point value when this occurs.

• TECHNICIAN MODE SCREEN 9/12

To be applicable, Dryer must include optional compressed air inlet temperature sensor and be configured to be activated remotely.



- ← **INLET TEMP ALARM:** Choose "ON" or "OFF".
- ← **HI INLET TEMP SETPOINT:** Value establishes the Alarm trigger point.
- ← **REM START STOP:** Choose "ON" or "OFF". When Remote Start/Stop function is activated ("ON"), dryer cannot be activated from the ON button on the Digital Controller.

• TECHNICIAN MODE SCREEN 10/12

For dryers equipped with the optional Fail-To-Shift function, this allows a user to either, enable this feature when the parameter is set to "ON", or disable it by pressing the +/- button to display "OFF" in the selection field. If the dryer is not equipped with this option, the selection will display "N/A".



- ← **FAIL TO SHIFT:** Choose "ON" or "OFF".
- ← **LOW PRES SETPOINT:** Value establishes the Alarm trigger point. Press "ENTER" to highlight the field, then use numeric keys to enter desired value. Select British (PSI) or Metric (BAR) values.

Permissible setting range is displayed.

- **TECHNICIAN MODE SCREEN 11/12**

The HI PRESS SETPT enables the user to set the high pressure set-point for the Fail-To-Shift function. Once completed, press the ENTER button to set the new value. Select either British (PSI) or Metric (BAR) values.



← **HIGH PRES SETPOINT:** Value establishes the Alarm trigger point. Press "ENTER" to highlight the field, then use numeric keys to enter desired value. Press ENTER again to set the value.

Permissible setting range is displayed.

The high pressure set-point will trigger a Fail-To-Shift alarm if the value does not rise above this set-point during the pressurization cycle for the tower that is designated for drying.

- **TECHNICIAN MODE SCREEN 12/12**

This screen permits the user to set the Date and Time format that will be depicted on certain screens and the Load Time parameter settings for the Compressor Interlock function.



← **DATE FORMAT:** Choose desired format.

← **LTA TIME:** Set interval for determination of average air compressor load.

- **6.9.5 ALARM INDICATION/EVENT LOGGING**

The event history function logs each event that occurs during operation of the dryer. This includes alarms, maintenance reminders & alerts, time & date stamp of dryer activation and shut-down.

- **ALARMS EVENT LOG SCREEN 1/2**



← Each event is logged on a single screen. UP and DOWN Navigation Buttons are used to view each event

← Event Type (Alarm, Reminder, ON, OFF, etc.), Step Number at which the event occurred, Time and Date Stamp will be noted.

• ALARMS EVENT LOG SCREEN 2/2



← When an alarm occurs, an Alarm Screen appears.

← Use the UP and DOWN Navigation Keys to acknowledge correction of the alarm condition. In certain cases, if the alarm is not acknowledged, the dryer sequence will pause or not operate until the alarm is resolved. The Alarm Screen will indicate the alarm type. The specific time & date of the alarm can be viewed through the Event Log.

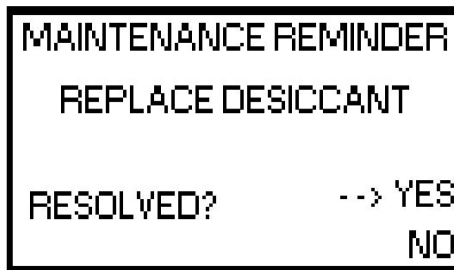

■ 6.9.6 MAINTENANCE ALERTS

General reminders for replacement of filter elements, inspection of drains as well as others.

• MAINTENANCE ALERTS SCREEN 1/5

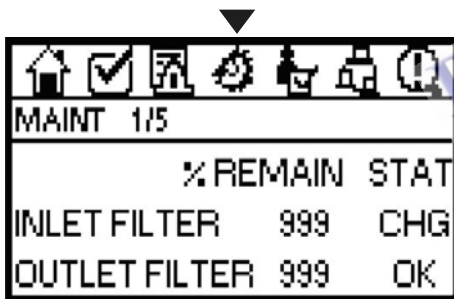

← % **REMAIN**: Part life remaining before replacement is recommended.

← **STAT**: Status of Part **CHG**: Part should be inspected & replaced.

OK: Part functioning as intended.

INLET FILTER: Filter element status based on operating hours.

OUTLET FILTER: Filter element status based on operating hours.

• MAINTENANCE ALERTS SCREEN 2/5

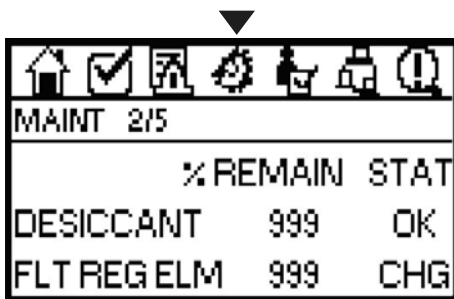

← % **REMAIN**: Part life remaining before replacement is recommended.

← **STAT**: Status of Part **CHG**: Part should be inspected & replaced.

OK: Part functioning as intended.

DESICCANT: Useful desiccant life remaining based on operating hours. Recommended time for inspection and determination of replacement requirement.

FILTER REGULATOR ELEMENT: Condition of filter element based on operating hours. Filter element should be inspected periodically and replaced as required to ensure proper operation of Control Air Valves.

- MAINTENANCE ALERTS SCREEN 3/5

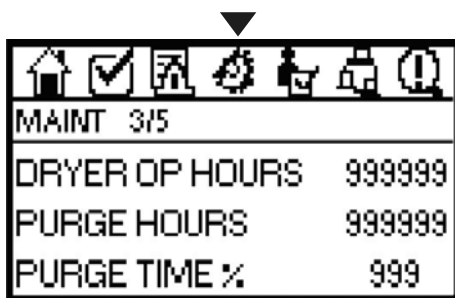

← **OPERATING HOURS:** Total operating hours since Dryer startup date.

← **PURGE HOURS:** Total hours Purge Valves have been active.

← **PURGE TIME %:** Percentage of dryer operating time Purge Air is utilized. This is dependent upon operating conditions and the demand on the dryer.

- MAINTENANCE ALERTS SCREEN 4/5

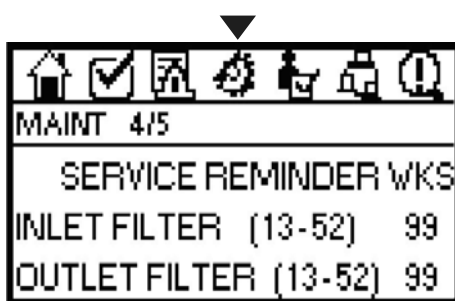

← **SERVICE REMINDER:** Enables user to setup Service Reminder Interval for key components. An alert will be displayed indicating that inspection & replacement may be required when the time Interval is reached.

← **INLET FILTER:** Reminder Interval (Weeks).

← **OUTLET FILTER:** Reminder Interval (Weeks).

- MAINTENANCE ALERTS SCREEN 5/5

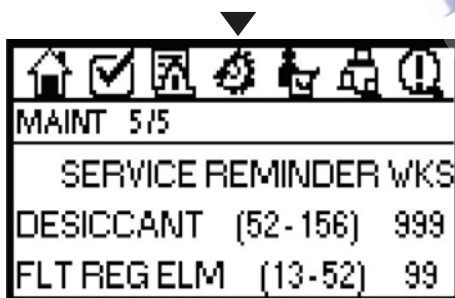

← **SERVICE REMINDER:** Enables user to setup Service Reminder Interval for key components. An alert will be displayed indicating that inspection & replacement may be required when the time Interval is reached.

← **DESICCANT:** Reminder Interval (Weeks).

← **CONTROL AIR FILTER/REG ELEMENT:** Reminder Interval (Weeks).

■ 6.9.7 GENERAL SETTINGS

Access for setting Time & Date; Language (English is default); Backup Solenoid drain adjustment.

- GENERAL SETTINGS SCREEN 1/3



← **LANGUAGE:** Press +/- key to select desired language.

← **UNITS:** Press +/- key to choose either Imperial or Metric units.

- GENERAL SETTINGS SCREEN 2/3

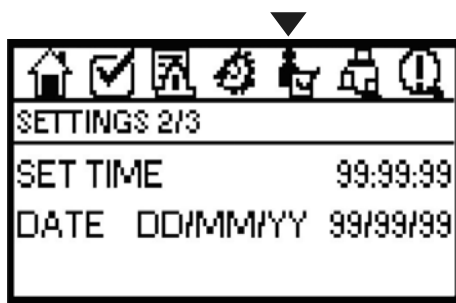

← **TIME:** Time is displayed in 24 hour format (Military Time).

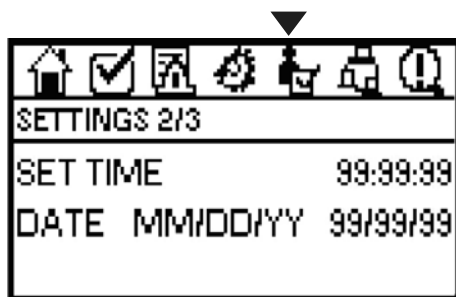

← **DATE:** MM/DD/YY can be altered to DD/MM/YY in TECHNICIAN MODE Screen 12.

Press Return key to highlight value to be changed then press Enter Button to set desired value. Use Right Navigation key to move cursor to change the value in each row.

- GENERAL SETTINGS SCREEN 3/3

For dryers equipped with optional Energy Management System (EMS) functionality. Dryer must be equipped with Dew Point Sensor:

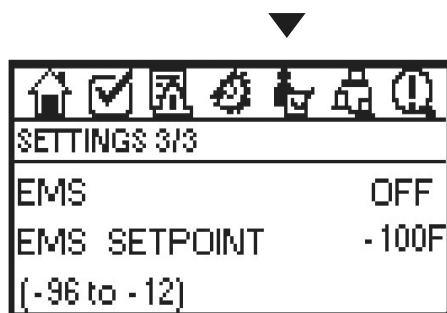

← **EMS:** Press +/- key to activate or de-activate EMS function. Value will display ON when activated.

← **EMS Setpoint:** Highlight the value and press Enter Button to choose from pre-defined values.

NOTE: Compressor Interlock Function is de-activated when EMS function is active.

■ 6.9.8 COMMUNICATIONS

Establish remote communication settings.

• COMMUNICATIONS SCREEN 1/4

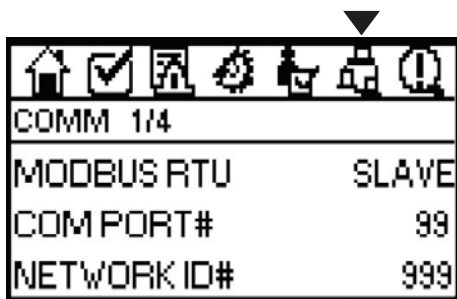

← **MODBUS RTU:** Controller is configured to be a slave.

← **COM PORT:** Port 1 is dedicated to Communications. For information only (non-adjustable).

← **NETWORK ID#:** To set: press Enter Button; use numeric keys to enter value; press Enter Button to save value.

• COMMUNICATIONS SCREEN 2/4

For information only (non-adjustable).

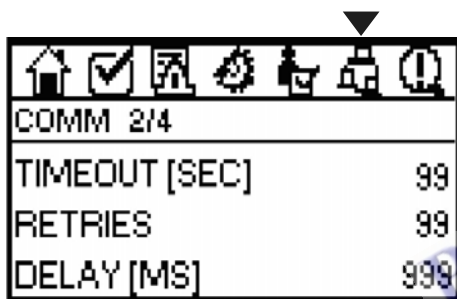

← **TIMEOUT:** Default - 1 seconds.

← **RETRIES:** Default - 3 attempts.

← **DELAY:** Default - 10 minutes.

• COMMUNICATIONS SCREEN 3/4

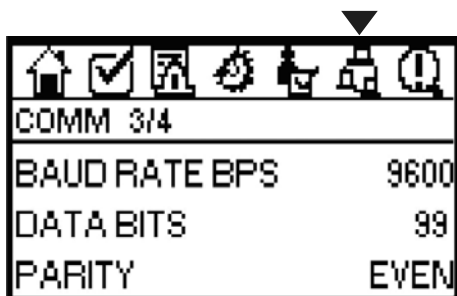

← **BAUD RATE:** Press Enter key to highlight field. Press +/- to select from preset values.

← **DATA BITS:** Default - 8. For information only (non-adjustable).

← **PARITY:** Default - None. For information only (non-adjustable).

• COMMUNICATIONS SCREEN 4/4

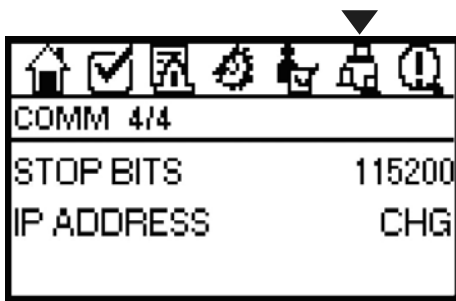

← **STOP BITS:** Default - 1. For information only (non-adjustable).

← **IP ADDRESS:** Press +/- key to access Setup Screen.

• COMMUNICATIONS SCREEN 4/4 (Setup)

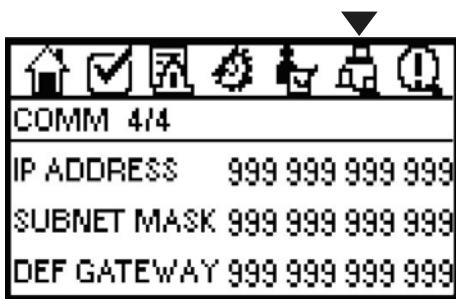

← **IP ADDRESS:** Default - 192.168.192.10. To change number, use UP/DOWN Navigation Keys to position Cursor where change is needed, press Enter key, use Numeral Keys to enter 3 digit number, press Enter to save.

← **SUBNET MASK:** Default - 255.255.255.0. To change number, use UP/DOWN Navigation Keys to position Cursor where change is needed, press Enter key, use Numeric Keys to enter 3 digit number, press Enter to save.

← **DEF GATEWAY:** Default - 192.168.192.254. To change number, use UP/DOWN Navigation Buttons to position Cursor where change is needed, press Enter Button, use Numeral Keys to enter 3 digit number, press Enter to save.

PORTAL
COMPRESSOR
Experience You Can Depend On
800-542-8300

■ 6.9.9 OPERATING STATUS

Displays information related to sensors, valve activation, drain status, etc.

• OPERATING STATUS SCREEN 1/7

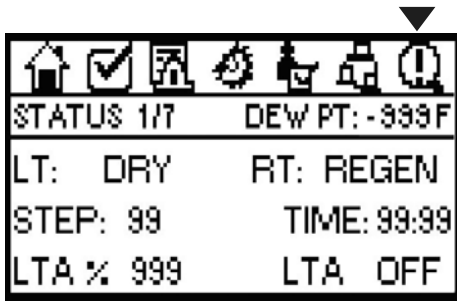

- ← **LT, RT:** Left Tower and Right Tower operating status.
- ← **STEP, TIME:** Step in Operating Cycle and time remaining within Step.
- ← **LTA%, Status:** Load Time Average based on air compressor Load/Unload relay output on fixed time interval. LTA STATUS: ON or OFF - LTA function can only be active when dew point monitoring function is not activated.

• OPERATING STATUS SCREEN 2/7

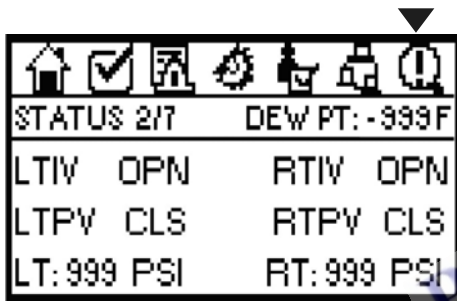

- ← **LTIV, RTIV:** Position of normally-open Left Tower and Right Tower Inlet Valves. Control outputs are de-energized when valves are open.
- ← **LTPV, RTPV:** Position of normally-closed Left Tower and Right Tower Purge Valves. Control outputs are energized when valves are open.
- ← **LT, RT:** Indication of Left Tower and Right Tower Pressure (PSI) when dryer is equipped with Fail To Shift option.

• OPERATING STATUS SCREEN 3/7

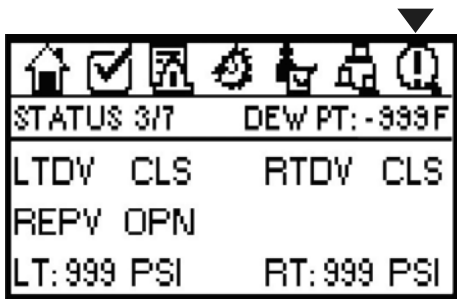

- ← **LT, RT:** Indication of Left Tower and Right Tower Pressure (PSI) when dryer is equipped with Fail To Shift option.

• OPERATING STATUS SCREEN 4/7

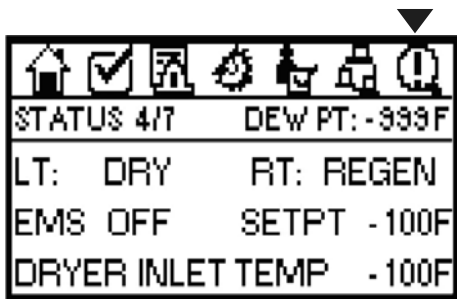

- ← **LT, RT:** Left and Right Tower operating status - DRYING or REGENERATING.
- ← **EMS, SETPT:** Status of Energy Management System option - ON or OFF. Indication of Setpoint: -40 and -100. Display of NA if option is not installed.
- ← **DRYER INLET TEMP:** (Optional) Indication of compressed air temperature at dryer Inlet. Display of NA if option is not installed.

• OPERATING STATUS SCREEN 5/7

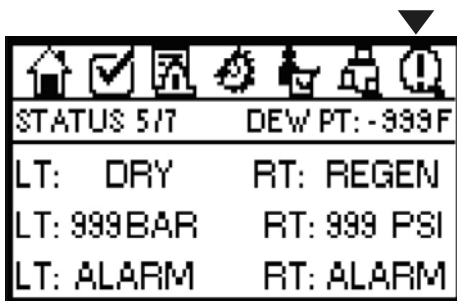

- ← **LT, RT:** Left and Right Tower operating status - DRYING or REGENERATING.
- ← **LT, RT:** Left and Right Tower pressures with Fail To Shift Tower Pressure Monitoring (Optional). Display of NA if option is not installed.
- ← **LT, RT:** Display of ALARM if Left or Right Tower does not achieve proper pressure during normal operation or at time of tower shift.

• OPERATING STATUS SCREEN 6/7



- ← **INLET FLT:** Optional Inlet Filter Delta P Alarm. Actuated by either differential pressure switch or transducer. Displays: CHG for DP switch; DP value for transducer.
- ← **OUTLET FLT:** Optional Outlet Filter Delta P indication. Display of NA if option is not installed.

• OPERATING STATUS SCREEN 7/7

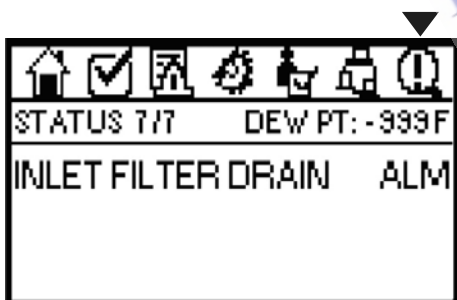

- ← **FILTER DRAIN STATUS:** Displays the status of the optional Electronic No-Air Loss Drain provided for the Inlet Filter. Display of NA if option is not installed.

PORTLAND
 COMPRESSOR
 Experience You Can Depend On
 800-542-8300

7.0 ALARMS AND INDICATORS

■ 7.1 MOISTURE INDICATOR

The Blue Moisture Indicator (BMI) analyzes a sample of the control air supply that is taken from the dryer outlet. The BMI provides an indication of dew point deterioration at the outlet of the dryer. Under normal operating conditions, the BMI appears blue in color. In the event of a dryer malfunction or prolonged dryer shut down, it will turn gray in the presence of moisture.

The dryer sequence will not start if the tower pressures are below 80 PSI at time of dryer startup. For dryers equipped with the EMS option, the Dew Point Transmitter must not be installed until the dryer has operated continuously for 24 hours and the Blue Moisture Indicator (BMI) appears blue in color.

ALARMS AND INDICATORS

■ 7.2 FAIL-TO-SHIFT AND TOWER PRESSURE ALARM MONITORING

The optional Fail-To-Shift alarm provides an indication of a valve failure that could occur when the towers transition between the drying and regeneration steps. Pressure transducers are utilized to constantly monitor the pressure of the towers during the drying and regeneration steps to ensure correct tower pressure values are maintained during each step.

The tower designated for regeneration should be under 7 PSI during this step while the other tower should be maintained at line pressure. When the mufflers are properly serviced and maintained, regenerating tower pressure will typically be under 3 PSI. An alarm will be triggered under the following conditions:

1. De-pressurization Fault: The tower designated for regeneration does not de-pressurize below 7 PSI within a designated time period immediately after the designated purge valve is energized AND/OR.
2. Pressurization Fault: The previously regenerated tower that switches to drying does not pressurize above a high pressure set-point within a designated time period.

The Fail-To-Shift option can be de-activated by accessing SCREEN 10 in TECHNICIAN MODE. The function can be turned off if a fault occurs with a pressure transducer.

During normal dryer operation, the Controller will also monitor the tower pressure value of the Drying tower to ensure the system is operating properly. The dryer must be equipped with the Fail-To-Shift control option for this to operate properly. TABLE 7.4 ALARM STATES details a list of Alarms & Controller actions that occur if an irregular pressure value is detected during normal HLA dryer operation.

■ 7.3 ENERGY MANAGEMENT SYSTEM

The Energy Management System (EMS) feature is designed to minimize the use of purge air during low flow or low water loading conditions. On -40°F (-40 °C) units, a dew point sensor samples the moisture content from the online tower and provides a signal to the controller. This function utilizes a Dew Point Transmitter that monitors the dew point of the air exiting the dryer. Please note that the Dew Point Transmitter should not be installed on a new start-up and not until the dryer has operated continuously for a minimum of 24 hours and the BMI appears blue in color.

When the EMS function is activated, a 30 minute delay will be initiated to allow the dryer to regenerate. If the EMS set-point is satisfied for more than eight continuous hours, the Controller will revert to a fixed cycle for a period of 60 minutes in order to prevent the desiccant beds from becoming overloaded during rapid changes in compressed air demand.

See TABLE 7.4 ALARM STATES for a list of Alarms, Causes and Recommended Actions.

NOTICE

Do not restrict purge exhaust flow in any way. Keep purge mufflers clean. If exhaust air must be piped away from dryer, consult factory for correct pipe sizing and configuration.

■ 7.4 CONTROLLER ALARM / WARNING / MAINTENANCE ALERT SUMMARY

For dryers equipped with NEMA 4/Digital Controller option.

ITEM	ALARM / ALERT MESSAGE	CAUSE	CONTROL SEQUENCE ACTION			RECOMMENDED ACTION
			CONTINUES TO OPERATE	STOPPED / PAUSED	ALARM CONTACT	
1	Fail-To-Shift (Dryer must be equipped with this Option).	1.De-pressurization Fault: The tower designated for regeneration does not de-pressurize below 7 PSI within a designated time period immediately after the designated purge valve is energized.		Paused	Activated while alarm condition is true	1. Troubleshooting sequence: <ol style="list-style-type: none"> Verify operation of purge valve. Use test button on control air solenoid to verify operation. Inspect control air solenoid valves are functioning properly & pilot airlines are not clogged. Inspect pressure transducer readout values. Values should read close to gauge values. Inspect mufflers for clogging. Please follow proper safety procedures when servicing mufflers. Inspect control air filter regulator and verify element is not clogged.
		2.Re-pressurization Fault: The previously regenerated tower that switches to drying does not pressurize above a high pressure set-point within a designated time period.				2. Verify the following: <ol style="list-style-type: none"> Appropriate purge valve is closed. Inspect control air solenoid valves are functioning properly & pilot airlines are not clogged. Inspect pressure transducer readout matches tower pressure gauge values. Verify repress valve is operating properly (-100°F PDP) applications only. Inspect control air filter regulator and verify element is not clogged.
2	Low Tower Pressure (Dryer Must Be Equipped with Fail To Shift Option)	1.Right & left tower pressure values are below 80 PSI prior to initiating dryer operation.		Stopped	Activated while alarm condition is true	1. Dryer must be allowed to pressurize prior to starting the dryer sequence.
		2.Pressure of the drying tower falls below 80 PSI after the tower shift has been completed. The alarm will be triggered if the pressure value remains below 80 PSI for 10 seconds continuously.		Paused	Activated while alarm condition is true	2. The check valves should be inspected and the system pressure should be verified. <ol style="list-style-type: none"> Restart dryer after pressure values have been verified. The dryer will restart from the initial step.

ITEM	ALARM / ALERT MESSAGE	CAUSE	CONTROL SEQUENCE ACTION			RECOMMENDED ACTION
			CONTINUES TO OPERATE	STOPPED / PAUSED	ALARM CONTACT	
3	Muffler Clog Warning (Must have Fail To Shift Option)	Pressure value of regeneration tower rises above 7 PSI after the de-pressurization step is completed. (Regeneration tower pressure should be below 7 PSI.)	X	Paused	Activated while alarm condition is true	<ol style="list-style-type: none"> 1. Shut-down dryer and follow proper safety pre-cautions. 2. Inspect & replace mufflers. 3. Restart the dryer and verify regenerating tower pressure is below 3 PSI.
4	Inlet Filter Pressure Drop Warning (Optional)	Filter element clogged and activates either pressure switch or pressure transducer.	X		Activate while alarm condition is true	<ol style="list-style-type: none"> 1. Shut-down dryer and follow proper safety pre-cautions. System must be de-pressurized prior to servicing. 2. Inspect & replace filter elements. 3. Restart the dryer and verify alarm is resolved.
5	Outlet Filter Pressure Drop Warning (Optional)	Filter element clogged and activates either pressure switch or pressure transducer.	X		Activate while alarm condition is true	<ol style="list-style-type: none"> 1. Shut-down dryer and follow proper safety pre-cautions. System must be de-pressurized prior to servicing. 2. Inspect & replace filter elements. 3. Restart the dryer and verify alarm is resolved.
6	High Inlet Temperature (Optional)	Alarm is triggered if the temperature of the compressed air exceeds the set-point value established in the technician mode	X		Activated while alarm condition is true	<p>Inspect compressor after-cooler for clogging and blower for cooler.</p> <p>High inlet temperatures will reduce dryer performance.</p>
7	Low Inlet Temperature Warning (Optional)	If the inlet temperature falls below 70°F, a warning will be displayed.	X		No Alarm	Lower inlet temperatures to the dryer may lead to performance problems.
8	Inlet Temperature Fault (Optional)	Fault occurs if the temperature sensor is operating out of the normal measurement range.	X		No Alarm	Check wiring and verify that correct resistor is installed. Replace sensor as required.
9	Filter Drain Alarm (Optional - Electronic No Air Loss)	Electronic no air loss drain alarm contact is triggered.	X		Activated while alarm condition is true	Inspect drain sump for debris and test fire drain. Verify that drain is operating properly using test button after drain has been inspected.
10	Dew-point Xmtr Fault (DP Sensor Fault - Optional)	Fault occurs if the DP sensor is operating outside of the normal measurement range.	X		No Alarm	<p>Remove and inspect DP sensor. EMS will stop operating when this occurs.</p> <ul style="list-style-type: none"> • Please note that DP sensor should not be installed within the first 24 hours of continuous operation for the dryer. • Inspect wiring connections and resistor.

ITEM	ALARM / ALERT MESSAGE	CAUSE	CONTROL SEQUENCE ACTION			RECOMMENDED ACTION
			CONTINUES TO OPERATE	STOPPED / PAUSED	ALARM CONTACT	
11	High Dew-point Warning (Must be equipped with EMS Option)	Warning is triggered if the measured dew-point exceeds the set-point value established in screen 8 of the Technician mode.	X		Activated while alarm condition is true	Refer to General Troubleshooting section related to Elevated Dew-Point.
12	EMS Off Warning (Must have EMS option)	Warning is triggered if the DP sensor is out of range.	X		No Alarm	<ul style="list-style-type: none"> Remove and inspect DP sensor to determine condition of sensor. Refer to General Troubleshooting section related to Elevated Dew-point.
13	Pressure Sensor Fault	Warning is triggered if the tower pressure transducer is out of range. If Fault condition occurs, Fail-To-Shift function will stop operating.	X	Paused	Activated while alarm condition is true	<ul style="list-style-type: none"> Compare value displayed in controller with corresponding tower pressure gauge. Inspect wiring and resistor values. Determine if sensor needs to be replaced. Inspect valve operation
14	Inlet Filter Service Reminder	Maintenance Alert: A pop-up alert screen will be displayed to indicate that the inlet filter should be replaced. If the user selects "No", the reminder will be acknowledged and will re-appear within a two week period.	X		No Alarm	<ul style="list-style-type: none"> Follow proper safety shut-down practices and replace the inlet filter.
15	Outlet Filter Service Reminder	Maintenance Alert: A pop-up alert screen will be displayed to indicate that the outlet filter should be replaced. If the user selects "No", the reminder will be acknowledged and will re-appear within a two week period.	X		No Alarm	<ul style="list-style-type: none"> Follow proper safety shut-down practices and replace the inlet filter.
16	Desiccant Service Reminder	Maintenance Alert: A pop-up alert screen will be displayed to indicate that the desiccant bed should be inspected. If the user selects "No", the reminder will be acknowledged and will re-appear within a two week period.	X		No Alarm	<ul style="list-style-type: none"> Follow proper safety shut-down practice to visually inspect desiccant charge in each vessel and submit to IR for testing. Determine if desiccant replacement is required.
17	Filter Regulator Element Service Reminder	Maintenance Alert: A pop-up alert screen will be displayed to indicate that the filter regulator element should be replaced. If the user selects "No", the reminder will be acknowledged and will re-appear within a two week period.	X		No Alarm	<ul style="list-style-type: none"> Follow proper safety shut-down practices and replace the inlet filter.

8.0 INSTALLATION AND START-UP

■ 8.1 APPLICATION AND CHECK ANALYSIS

To achieve the best dryer performance, you should carefully check that the design and installation requirements outlined below are satisfied.

NOTICE

The standard dryer is not rated for any gas other than air.

The dryer is designed to be operated with a compressed air inlet temperature ranging from 80°F (26,67 °C) to up to 120°F (48,89 °C) and at an operating pressure ranging from 80 PSI to 150 PSIG. The volume of air will be dependent on the system operating pressure. The air compressor delivering air to the dryer must be sized properly to handle both the demand and the purge air requirements necessary for regeneration.

The standard HLA series heatless desiccant dryer is rated for a maximum allowable working pressure of 150 PSIG (11.35 bar).

The factory should be consulted if the dryer is to be operated at pressures below 80 PSIG (5.51 bar) to verify sizing and proper configuration.

The standard dryer is rated to operate at an inlet temperature and pressure of -100°F (37,7 °C) @ 100 PSI (6.89 bar). The operating conditions should be verified prior to installing and operating the dryer to ensure it is properly sized. A dryer with greater capacity may be required to achieve expected dew point performance in installations with elevated inlet air temperatures. Lower inlet temperature conditions may also reduce dryer performance.

It is important to note that delivering lower compressed air inlet temperature levels will reduce drying performance. A minimum compressed air inlet temperature of 80°F (26,67 °C) is required to be supplied to the dryer for proper operation.

The dryer should generally be installed in an enclosed area where the ambient temperature does not drop below 50°F (10 °C) and is not above 120°F (48,89 °C). Please consult factory for outdoor installation applications where additional provisions maybe required for lower ambient conditions.

NOTICE

Ingersoll Rand recommends the mufflers be cleaned after initial start-up to remove any desiccant dust generated during dryer shipment. After running the dryer for the initial 30 minute period, de-energize/ depressurize the dryer and remove the mufflers. Disassemble and clean the removable insert inside the muffler core. Reinstall the mufflers prior to operating dryer. Periodic inspection of the mufflers is required to ensure proper dryer operation.

A minimum Inlet Temperature of 80°F (26,67 °C) is required for proper dryer operation.

■ 8.2 LOCATING AND MOUNTING

Using a forklift, lift the dryer only at the lift points identified

with labeling. Use care to avoid damage to manifold.

Bolt the dryer to the foundation using the bolt holes provided in the base frame. Anchor bolts should project a minimum of 3.5 inches above the foundation. Refer to SECTION 12, GENERAL ARRANGEMENT DRAWINGS, for details.

■ 8.3 PIPING

Pipe the compressed air lines to the inlet and outlet connections. For 1,800-5,000 SCFM dryer models with filters that ship loose, locate the prefilters as close as possible to the dryer. Ensure the positioning allows for ease of servicing. Refer to the General Arrangement drawing.

Note that the wet air inlet is at the dryer's lower manifold, while the dry air outlet is at the dryer's upper manifold. In situations where air supply is required 24 hours a day (where it is undesirable to interrupt the compressed air flow), an optional three valve by-pass system is recommended to bypass the dryer. Use the fewest elbows necessary to keep pressure drop at a minimum. THE BYPASS SHOULD BE USED WHEN TROUBLESHOOTING AIR COMPRESSOR OPERATION OR WHEN SERVICING THE DRYER. TO PREVENT FLOODING OF THE DESICCANT BED WHEN THE DRYER IS OFF.

Once all piping has been connected, all joints, including those on the dryer, should be soap bubble tested at line pressure to ensure no joints have been damaged in transit and during site placement. All installed piping must be self-supported. The dryer manifold piping cannot be used to support the interconnecting piping.

■ 8.4 FILTRATION

NOTE: A Prefilter and an Afterfilter are provided with your dryer.

NOTICE

All HLA model dryers must have proper filtration. Liquid water and oil must be removed before compressed air enters the dryer. Ensure separators, Prefilters and drains are in good working order. Failure to do so will void warranty.

Coalescing Prefilters, located before the dryer, protect desiccant beds from contamination by oil, entrained water, pipe scale, etc., thereby, extending dryer desiccant life. Locate Prefilters as close to dryer as possible. Prefilters must be provided with drains to prevent liquid water from entering the desiccant beds. Drain maintenance is not covered by the standard warranty.

It is recommended that a mechanical separator with a properly functioning drain be installed immediately preceding the Prefilter to remove bulk liquid and entrained water.

The Particulate Afterfilter, located after the dryer, helps eliminate the possibility of desiccant dust carryover into the air system.

To ensure proper dryer operation, the pre-filter drain(s) must be inspected periodically.

■ 8.4.1 FILTER DRAIN VALVE

HLA dryer models are furnished from the factory with filters that include an automatic condensate drain valve. The drains require periodic inspection and maintenance to ensure proper dryer operation. Drain maintenance is not covered by the standard warranty.

Filters on 90-1,500 SCFM dryers include automatic drain valve PN: 24335028. This drain must be checked for correct configuration prior to pressurization of the dryer as follows:

- Filters must be oriented vertically for proper operation.
- The drain stem must be properly adjusted as follows:
- Twist the drain stem (No. 18 in Figure 2) to set for AUTOMATIC (Normal) or MANUAL (Test) operation (See Figure 1 below).
- Twist the stem fully clockwise (when viewed from the bottom of the filter bowl) for AUTOMATIC draining of condensate. This is the Normal position.
- Twist the stem fully counter-clockwise (when viewed from the bottom of the filter bowl) for MANUAL draining of condensate (Test/Bleed) or if connected to an external drain.

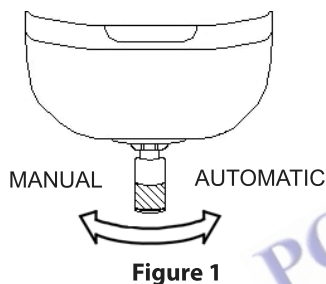

Figure 1

Minimum operating pressure of 22 psig(2.53 bar) is required for the float that's within the drain assembly to seat properly. Pressures below 22 psig(2.53 bar) will allow air to escape from the drain. This will occur when the compressed air system is being pressurized.

WARNING

Proper safety precautions must be followed when servicing filters and drains. Filter bowl must be depressurized before servicing drain.

Service should only be performed by qualified personnel.

Before first-time use, and after maintenance, the drain stem (See 18 in Figure 2) should be twisted fully clockwise to provide AUTOMATIC operation (See Figure 1).

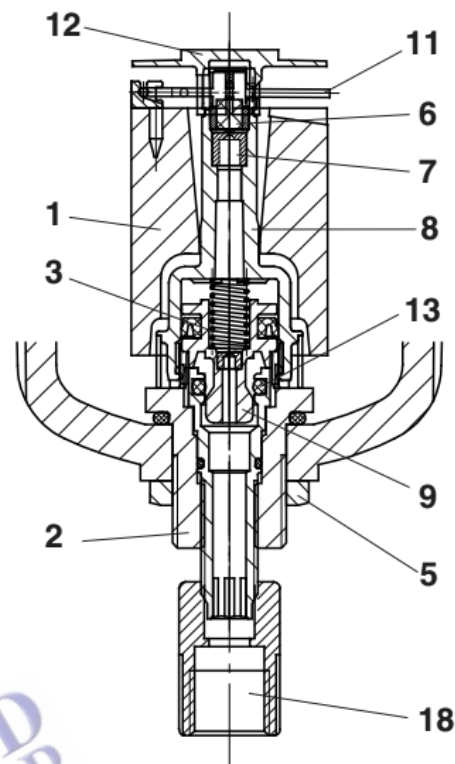

Figure 2

Method of Operation (See Figure 2)

- When the filter pressure is below 22 psig(2.53 bar), the Piston (9) is held in an open position by the Spring (3).
- When filter is pressurized above 22 psig(2.53 bar), the Piston closes the drain Aperture at the O-Ring (13).
- As the condensate collects in the Filter Bowl, the Float (1) is pushed upward, opening the Nozzle (7) and allowing air to reach the top of the Piston (9). This causes the Piston to move downward, opening the Aperture at the O-Ring (13) for drainage of the condensate.

Maintenance and Initial Operation

- After initial startup, inspect drain(s) for system debris. Clean as required. Float drain assembly is screwed into bottom of Bowl from the inside.
- Drains require periodic inspection and maintenance to ensure proper operation. Clogging of drains due to system debris or fouling is not considered warranty. Faulty drains must be returned to the factory for analysis in order to receive warranty credit.

Clogged drain screens can be cleaned by immersing drain in a detergent and rinsing thoroughly in water.

■ 8.5 ELECTRICAL CONNECTION

Make all electrical connections to the dryer as shown on the wiring diagram. Care must be taken to connect the proper voltages.

NOTICE

Dryer must be grounded with the full size ground wire connected to an earth ground.

NOTICE

Dryer must be fused according to NEC with the size fuse listed on the dryer serial nameplate, or on specification sheet in Technical Manual.

Size field connection knock-out for the conduit fitting required by the NEC. Installer must use UL Type 4 rated fitting.

The Compressor Interlock wiring should be verified if this function is to be activated at Start-Up.

■ 8.6 DESICCANT LEVEL VERIFICATION

Remove desiccant fill port at the top of each vessel (tower) and check desiccant level. The level should be consistent with the level depicted on the Desiccant Fill Chart in SECTION 9 MAINTENANCE AND SYSTEM CHECK of this Technical Manual.

■ 8.7 DEW POINT MONITOR (EMS OPTION)

The Dew Point Transmitter that is supplied with the dryer as a separate component (when the dryer is ordered with the EMS option) must not be installed until the dryer has been in operation for 24 hours. Color of the Blue Moisture Indicator (BMI) must appear blue before the Transmitter is installed.

The dryer Warranty will be voided if the Dew Point Transmitter is damaged as a result of flooding condition.

■ 8.8 START-UP PROCEDURE

A Startup Form (included with the manual) must be completed and submitted with the Warranty Card as part of the commissioning process. This is included with the dryer at shipment.

Prior to pressurizing the compressed air system, conduct a visual inspection of the dryer to verify that the unit was not damaged during the installation process. This includes:

- Inlet and outlet compressed air piping connections are properly supported.
- Pressure vessels are not damaged.
- Gauges are in good condition.
- Pneumatic control air hoses, inlet & outlet compressed air piping connections are properly supported and tightened
- Pre-filter and after-filter bowl are properly tightened.
- Drain lines are installed to the filters. Refer to Section 8.4.1.
- Fasteners securing Differential Pressure indicator to filter head are secured.
- Drain stem on each filter bowl is placed in the proper direction such that it operates in the manual mode for initial startup. Refer to Section 8.4.1. The drains will allow air to escape until the system reaches 22 PSI at which point

the internal float will seat properly and the drain will seal closed.

- Observe color of Blue Moisture Indicator.

NOTICE

The Dew Point Transmitter that is supplied with the dryer as a separate component must not be installed until the dryer has been in operation for 24 hours. Color of the Blue Moisture Indicator (BMI) must appear blue before the transmitter is installed.

After the visual inspection is complete, slowly pressurize the dryer and perform a verification check on the following items:

1. Verify that the air outlet shut-off valve is closed (if this is provided for the dryer). This can be provided as part of a three-valve bypass option for the dryer or field provided as part of the installation.
2. Check for air leakage prior to initiating flow through the dryer. Repair all leaks prior to starting the dryer. In order to maintain the drying performance of the dryer, any leaks must be fixed; most important are leaks identified on the outlet side of the dryer.

NOTICE

DO NOT FLOW COMPRESSED AIR THROUGH THE DRYER WHEN THE DRYER IS OFF. The desiccant beds will become flooded with moisture and the Warranty will be voided.

3. Verify the Purge Adjustment Valve is open.
4. Verify that pre-filter drain is blowing freely to drain residual water in the system. If no moisture is observed exiting the drain, turn drain stem to the automatic position. Verify drains ahead of dryer are functioning properly.
5. Turn the field disconnect switch to the ON position to apply power to the dryer. This will energize the Controller. Use proper PPE to verify that the voltage to the control panel matches the voltage / phase listed on the Serial Plate of the dryer. Do not apply power to the dryer until items 1 – 4 listed above have been verified. Do not apply power to the dryer or activate the dryer for operation until the air system checks are completed.
 - For dryers equipped with the EMS option, do not install the Dew Point Transmitter until the dryer has operated for a minimum of 24 hours to reach steady state conditions and the Blue Moisture Indicator appears blue in color. See the Warning note regarding installation of the Dew Point Transmitter. Enter the Settings Screen (3/3) and press the +/- key to de-activate the EMS function. Failure to follow this procedure will damage the Dew Point Sensor and will void the Sensor Warranty.

6. Adjust the Control Air Regulator to not exceed 100 PSIG (7,91 bar). The main flow inlet and purge valves are regulated to operate with a control air pressure level not to exceed 100 PSI (7,91 bar). Check the drain on the control air filter for moisture.
7. Press the ON button on the dryer Controller to initiate dryer operation.
 - Observe the operation of the dryer and verify that the dryer sequence is operating properly. The dryer Controller will automatically sequence the valves. Do not allow the dryer to operate if problems are observed.
 - Set the regeneration purge flow when the left tower is in the regeneration mode. Refer to section 6.4.
 - Slowly open the outlet air shut-off valve (if equipped) and allow the system to slowly pressurize.
8. Verify that the compressed air system remains pressurized.

NOTICE

At initial start-up, check the dryer operation for one or two cycles, especially at the time of the tower shift. Verify that all systems are operating in their proper order and sequence. If the dryer is not functioning properly, contact distributor or Ingersoll Rand Technical Service.

9. Verify the Technician and Maintenance settings of the dryer. Refer to Section 6.9 for further instructions.
 - Verify that the float drain(s) on the inlet filters and the drains on the air compressor after-cooler are operating properly. It is important to note that debris from the system piping may interfere with the operation of the float drain and it is the responsibility of the installer to verify this after the dryer is placed into operation. Drain maintenance or cleaning of system debris is not covered under warranty. Improper drain maintenance will result in damage to the desiccant beds and will void the warranty.
 - Once the system has operated for approximately (2) hours, the mufflers will need to be inspected / replaced. Follow proper safety procedures prior to replacing the mufflers. Mufflers are consumable items and are not warranted other than for manufacturing defects.

- Monitor the operation of the dryer and contact **Ingersoll Rand** if any problems arise during the startup process. The float drains on the dryer should be inspected daily to ensure proper operation.
- For dryers equipped with the EMS option, install the Dew Point Transmitter once the dryer has operated for a minimum of 24 hours and the BMI is fully blue in color. After the sensor has been installed, re-activate the EMS function through the Settings screen.
- For dryers equipped with the Fail-To-Shift option, verify the Tower Pressure gauge reading matches the pressure displayed on the Controller.
- Verify that alarms are cleared. Verify (if wired) Compressor Interlock Function. See SECTION 6.8.

10. Complete the Warranty Startup Card after the dryer is fully commissioned.

Long-Term Storage

If a dryer has been in storage for an extended period of time, the Blue Moisture Indicator (BMI) may appear gray in color. Follow the instructions above to start the dryer. Depending on the amount of time the unit was in storage, it may take between 8 and 12 hours before the BMI indicator turns blue.

NOTICE

When opening the outlet valve, ensure drying tower gauge maintains line pressure. Allowing the pressure in the dryer to drop will result in an overflow condition and potentially cause valves to stop functioning.

NOTICE

-100°F (37,7 °C) dryers require flow through the dryer to lower the pressure dew point to design levels. Failure to permit air flow through dryer (deadheading) will result in elevated outlet dew points. Once air is permitted to flow through the dryer, the pressure dew point will gradually reduce to design levels.

A Long-Term Storage option can be ordered separately.

■ 8.9 DRYER SHUT-DOWN SEQUENCE

The following procedures must be followed to correctly terminate dryer operation:

NOTE: The HLA dryer must remain pressurized during the Shut-Down Sequence.

- Press the red "OFF" button to de-activate the dryer operating sequence and de-energize the control valves. The main flow valves will be positioned to the default position:

- a. The Purge Valve will close
- b. The Regenerating Tower will re-pressurize
- c. The main Inlet Flow Valves will open

The system must remain pressurized in order for the main flow valves on the dryer to revert to the default position.

- The status line in the Home screen will display "OFF".

- The system will remain pressurized at all times. The dryer does not contain any provisions to permit a system bleed down.

- **System Bleed Down:** The operating sequence must be stopped by pressing the "OFF" button before the compressed air system is de-pressurized. This will allow the main flow valves to return to the default position and permit full de-pressurization of the system.

- The red "OFF" button only de-activates the dryer operating sequence - electric power will remain live within the dryer Main Panel.

WARNING

Failure to follow this procedure may result in the system retaining pressure within the dryer and potentially result in an unsafe condition for service personnel.

NOTICE

DO NOT FLOW COMPRESSED AIR THROUGH THE DRYER WHEN THE DRYER IS OFF. The desiccant beds will become flooded with moisture. The dryer Warranty will be void.

**PORTLAND
COMPRESSOR**
Experience You Can Depend On
800-542-8300

9.0 MAINTENANCE AND SYSTEM CHECK

■ 9.1 SCHEDULED MAINTENANCE

DAILY MAINTENANCE FUNCTIONS:

- Check and record inlet pressure, temperature and flow. Verify that it is within specifications.
- Check tower pressure gauge readings are within operating tolerance.
- Check dryer operation for proper cycling, depressurization and re-pressurization.
- Check that the Prefilter drain is operating properly and that there is no condensate discharged from Purge Mufflers.
- Verify that pressure in purging tower is 3 PSIG (1.22 bar) or less. If higher, muffler replacement is recommended. See SECTION 10 in this Technical Manual.
- Check dryer Digital Controller for Warnings or Alarms.
- Verify that Prefilter and Afterfilter differential pressure is within operating limits. Replace elements and/or cartridges as required.
- Check the Blue Moisture Indicator. Make sure air is bleeding through the indicator. The indicator will appear blue when air is dry.
- Check pilot air filter regulator.

MONTHLY MAINTENANCE FUNCTIONS:

- Check condition of Mufflers by reading tower Pressure Gauge when the tower is in the re-generation cycle. If pressure is above 3 PSIG(1.22 bar), Muffler replacement may be required.

NOTE: Ingersoll Rand recommends the mufflers be cleaned after initial start-up to remove any desiccant dust generated during dryer shipment. After running the dryer for the initial 30 minute period, de-energize/depressurize the dryer and remove the mufflers. Disassemble and clean the removable insert inside the muffler core. Reinstall the mufflers prior to operating dryer. This procedure should be repeated within the first seven days of dryer operation.

SEMI-ANNUAL MAINTENANCE FUNCTIONS:

- Check outlet dew point.(EMS option only)
- Check Pilot Air Filter element and clean or replace as required.
- Replace Prefilter and Afterfilter elements and/or cartridges.

ANNUAL MAINTENANCE FUNCTIONS:

- Check desiccant and replace if necessary.
- Inspect and clean Pilot Air Control Solenoid Valves, check valves and flow valves. Rebuild and / or replace as required.
- Test lights and switches, replace as necessary.
- Replace Drains on Prefilter and Afterfilter.
- Test electrical components, replace as necessary.
- Check for loose electrical wiring connections and tighten as required.

EVERY TWO YEARS:

- Inspect valves and replace angle valve bonnets if not functioning properly (Preventive).
- -100°F (73.33 °C) dryers – Rebuild control air solenoid valve set (Preventive).
- Replace check valves (Preventive).

■ 9.2 PREFILTERS AND AFTERFILTERS

PREFILTERS - The cartridges of the Prefilter must be changed as often as required to prevent contamination of the regenerative dryer's desiccant bed.

The Prefilter and automatic drain must be checked daily. To prolong filter cartridge life, it is recommended that a mechanical air / moisture separator be placed immediately before the prefilter.

AFTERFILTERS - The purpose of the Afterfilter is to remove residual desiccant dust. Depending upon equipment application and usage, frequency of filter element change will vary. It is recommended that, at the minimum, the filter element be changed every six months.

9.2.1 FLANGED FILTERS:



STEP1- Using a 2" socket with an extension, carefully loosen element.



STEP 2- Remove old element from filter housing.



STEP 3 - Install new element by carefully inserting element in top plate.



STEP 4 - Hand tighten element in place until element o-ring contacts top plate.



STEP 5 - Using a 2" socket with an extension, tighten element one half turn. DO NOT OVERTIGHTEN.



STEP 6 - Repeat procedure as required to replace all elements.

NOTICE

Should the drying system be overloaded and/or malfunctioning, causing high pressure drop, Afterfilters may prematurely plug. This problem can be avoided by frequent inspection and proactive replacement of cartridges.

■ 9.3 PILOT AIR CONTROL SOLENOID VALVES AND FILTER/REGULATOR

The length of time the pilot air valves can reliably operate without replacement is dependent upon the dryer operating cycle. On **Ingersoll Rand** -40°F (-40 °C) dew point dryers, replacing the valves every 36 months is recommended. For -100°F (37,7 °C) units, it is recommended that the Pilot Valves be replaced every 6 months. The control air regulator should be set for 100 PSI.

■ 9.4 MUFFLER CHANGEOUT PROCEDURE

WARNING

To avoid injury, depressurize dryer before performing any service.

- Depressurize the dryer. Disconnect dryer from electric power source.
- Replace mufflers.
- Follow Start-up Procedure described in SECTION 8.8 of this Technical Manual.
- Turn control power back on.

■ 9.5 ANGLE SEATED PURGE AND SWITCHING VALVES

- These valves have two control ports: one on top and the other on the back side of the bonnet.
- MAIN INLET FLOW VALVES – Normally-Open (N.O.) valves for inlet air or repressurization. Control air is supplied through the tubing that is connected to the top port.
- PURGE VALVES – Normally-Closed (N.C.) for purge air flow. Control air is supplied through tubing that is connected to the side port. When control air is supplied to the valve, a position indicator will extend from the top of the bonnet, indicating that the valve is open.

■ 9.6 OUTLET CHECK VALVES

Outlet check valve sealing can be verified by depressurizing the dryer and slowly applying pressure to the outlet. The valves should seal and prevent air from pressurizing the towers. If a tower begins to pressurize, the check valve on that side requires replacement.

WARNING

To avoid injury, depressurize dryer before performing any service.

■ 9.7 DESICCANT CHANGEOUT PROCEDURE

When it becomes necessary to replace the desiccant in the towers, or on units that are shipped without the desiccant installed, observe the following procedure:



Desiccant will produce dust during the changeout procedure. Be sure to wear respiratory protection during the draining and filling process to minimize inhalation of desiccant dust.

- After cleaning the retainer Screens, replace Screens and re-attach the outlet port plug.
- With the fill port plug removed, fill the dryer tower with the appropriate grade and size desiccant. The level of the desiccant should be below the top retainer screen as shown on the Desiccant Fill Chart on the following page of this Technical Manual.
- When the towers have been filled to the correct level, replace the fill port plug on each tower.
- Any connections and joints disturbed in the desiccant changeout procedure should be leak tested prior to re-commissioning the dryer.

The standard units are furnished with fill and drain ports on each desiccant tower. Remove the caps on both ports.

- To assist in getting the desiccant to flow from the tower, insert a small rod into the drain port as necessary. This may be required as the desiccant is packed into the towers which may interfere with the desiccant flow from the towers.
- Retainer Screens, located at the inlet and outlet piping connections of each tower, are removable on all models. It is suggested that these Screens be removed and cleaned at the time of desiccant changeout. The Screens can be accessed by disconnecting the upper and lower manifolds from the dryer towers.

**PORTLAND
COMPRESSOR**
Experience You Can Depend On
800-542-8300

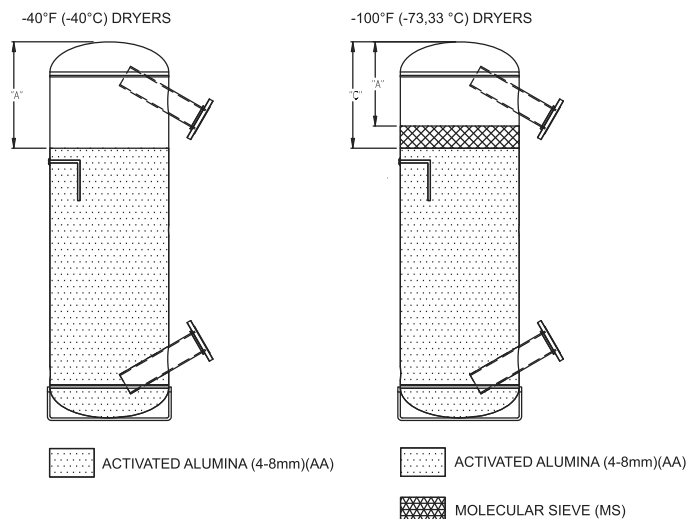

DESCRIPTION	PART #
ACTIVATED ALUMINA QTY. (1) 50 LB. BAG	38004834
ACTIVATED ALUMINA QTY. (42) 50 LB. BAGS	38004933
ACTIVATED ALUMINA QTY. (1) 2000 LB. SACK	38340659
MOLECULAR SIEVE QTY. (1) 275 LB. DRUM	38449971

MODEL	DIMENSIONS (INCH)		-40°F (-40 °C)	-100°F (37,7 °C) DRYERS	
			DRYERS (AA)	(AA)	(MS)
	A	C	lbs./Dryer	lbs./Dryer	
HLA90	23	30.00	100	75	25
HLA120	17	20.38	134	100	34
HLA160	22	29.75	192	150	50
HLA200	14	21.50	236	177	59
HLA250	23	28.00	290	215	75
HLA300	12	21.25	344	258	86
HLA400	11	22.25	470	352	118
HLA500	27	32	638	478	160
HLA600	17.5	29	748	560	188
HLA800	34	41	900	675	225
HLA1000	23	31.5	1100	825	275
HLA1200	10	23.75	1270	950	320
HLA1500	12	23.25	1600	1200	400
HLA1800	35	45.75	2000	1500	500
HLA2100	25.5	38.5	2340	1755	585
HLA2700	6	26	2928	2196	732
HLA3300	16.25	35.25	4000	3000	1000
HLA4000	7.75	29	4400	3300	1100
HLA5000	9	28	5600	4200	1400

NOTE: Desiccant weight shown is per-dryer.

10.0 TROUBLESHOOTING

For Troubleshooting Procedures, refer to maintenance descriptions in SECTION 9 as required.

PROBLEM	PROBABLE CAUSE	CORRECTIVE ACTION
Elevated Dew-point	Insufficient purge flow	<ul style="list-style-type: none"> • Check purge flow settings. Verify that purge gauge is reading proper value. • Inspect purge valve & control air solenoid valves for proper operation. • Inspect mufflers for clogging.
	Improper valve operation	<ul style="list-style-type: none"> • Verify operation of main flow and purge valves. • Inspect control air solenoid valves for proper operation. • Verify check valves are maintaining desired pressures by using valve test functions. Refer to valve test section.
	Inlet air pressure below design condition.	<ul style="list-style-type: none"> • Check pressure source and inspect piping system for leakages. • Verify that the dryer was sized appropriately for the operating conditions.
	Flow rate is higher than design condition.	<ul style="list-style-type: none"> • Verify that compressor sizing is properly matched to dryer capacity. • For specialty systems where the outlet of the dryer is piped to a booster compressor, verify that the flow of the booster compressor is below the rated capacity of the dryer. Excessive flow will fluidize desiccant bed and result in dusting and significantly reduce performance.
	Inlet temperature to the dryer exceeds the rated capacity of the dryer.	<ul style="list-style-type: none"> • Inspect the air compressor after-cooler and drain to ensure proper operation. After-cooler may require cleaning in to operate properly. • Verify the inlet temperature does not exceed 120°F under normal operating conditions. For applications that approach 120°F on a continuous basis, dryer sizing should be reviewed prior to operation of the dryer. The standard design is rated based on an inlet condition of 100°F @ 100 PSI and will not deliver proper performance if it is undersized.
	Desiccant bed is flooded with moisture. The BMI will turn gray when this occurs.	<ul style="list-style-type: none"> • Verify that the air compressor after-cooler drain is functioning properly. • The desiccant will become saturated if compressed air is permitted to flow through the dryer before it is operating. • If this occurs, the performance of the dryer will not easily recover and this will void the warranty on the desiccant material.
Blue Moisture Indicator Turns Gray	Indicator is saturated as a result of an elevated dew-point.	Refer to elevated dew-point corrective actions listed above.
Excessive Pressure in Tower Designated For Regeneration (Above 3 PSI)	Purge Muffler is clogged.	Inspect purge mufflers for clogging and replace as required. Follow proper safety pre-cautions during this process.
	Air leak across Purge Muffler.	Determine if inlet valves and outlet check valves are functioning properly. Refer to valve test section.
Inability to Maintain Line Pressure On Drying Tower	Leaking check valve.	Utilize valve test function to determine if inlet and outlet valves are functioning properly.



11.0 PURGE CHARTS

Dryer Model: **HLA 90**
 Purge Pressure Setting: **48 psig (4.32bar) @ 14 SCFM**
 Purge Orifice: **9/64" (3.5 mm)**

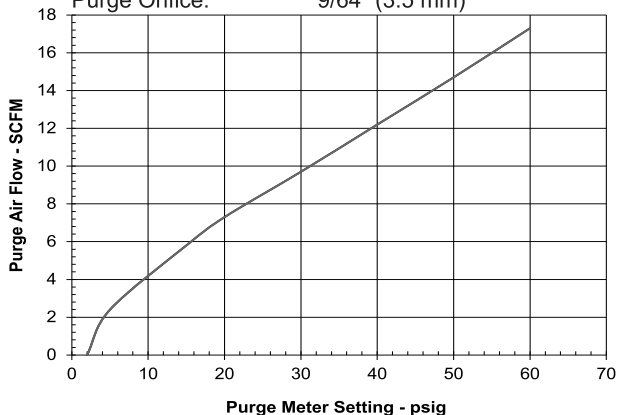

Dryer Model: **HLA 120**
 Purge Pressure Setting: **53 psig (4.67bar) @ 19 SCFM**
 Purge Orifice: **5/32" (3.8 mm)**

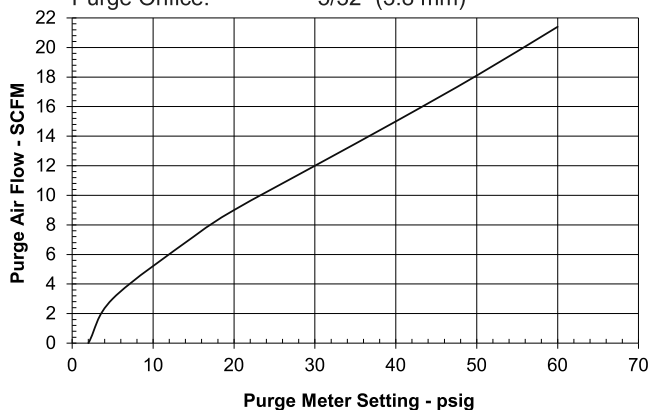

Dryer Model: **HLA 160**
 Purge Pressure Setting: **50 psig (4.46bar) @ 26 SCFM**
 Purge Orifice: **3/16" (4.7 mm)**

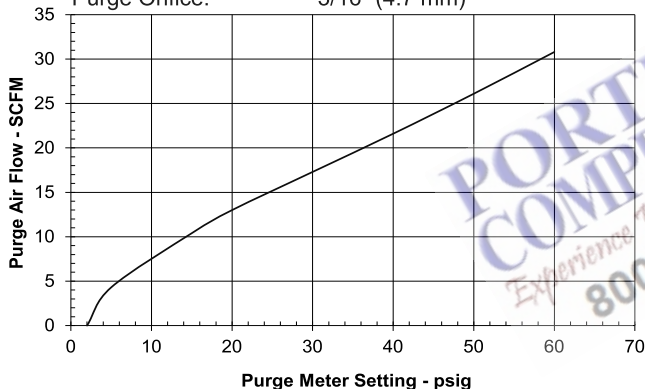

Dryer Model: **HLA 200**
 Purge Pressure Setting: **42 psig (3.91bar) @ 30 SCFM**
 Purge Orifice: **7/32" (5.3 mm)**

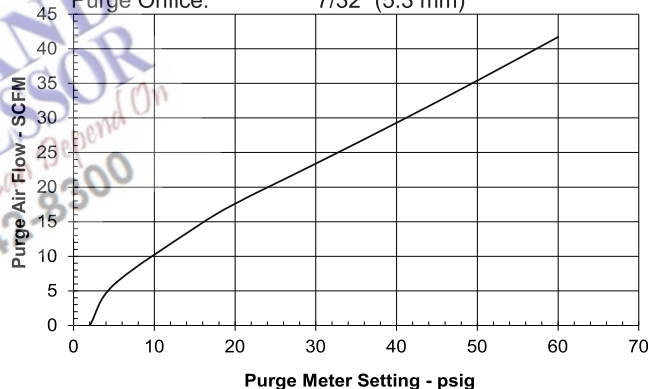

Dryer Model: **HLA 250**
 Purge Pressure Setting: **42 psig (3.91bar) @ 40 SCFM**
 Purge Orifice: **1/4" (6.3 mm)**

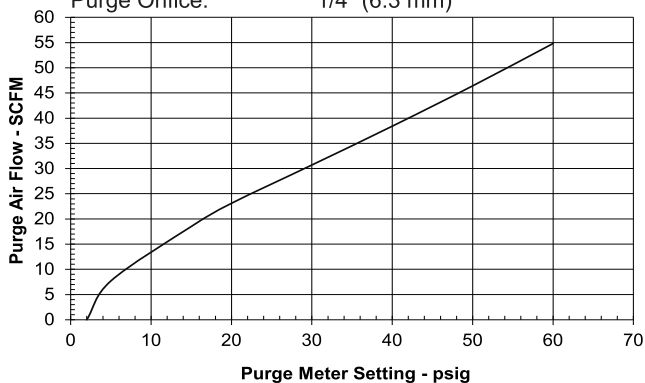

Dryer Model: **HLA 300**
 Purge Pressure Setting: **40 psig (3.77bar) @ 48 SCFM**
 Purge Orifice: **9/32" (7.1 mm)**

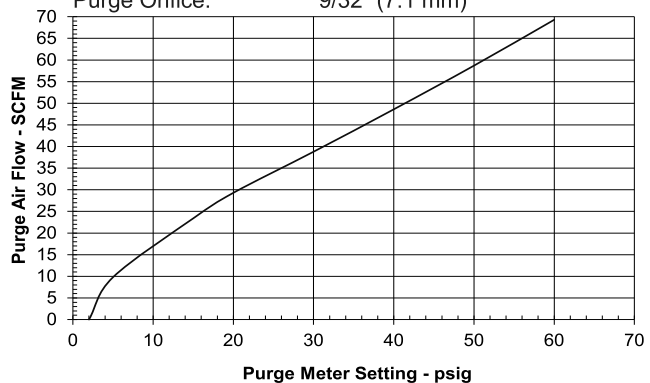

Dryer Model: **HLA 400**
 Purge Pressure Setting: **45 psig (4.11bar) @ 65 SCFM**
 Purge Orifice: **5/16" (7.9 mm)**

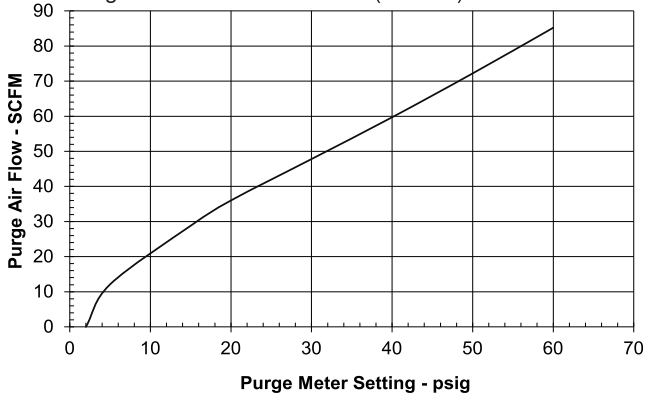

Dryer Model: **HLA 500**
 Purge Pressure Setting: **35 psig (3.43bar) @ 81 SCFM**
 Purge Orifice: **3/8" (0.94 mm)**

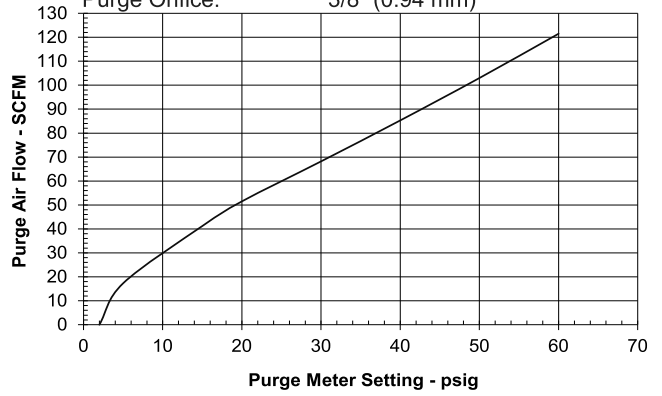

Dryer Model: **HLA 600**
 Purge Pressure Setting: **41 psig (3.84bar) @ 93 SCFM**
 Purge Orifice: **3/8" (0.94 mm)**

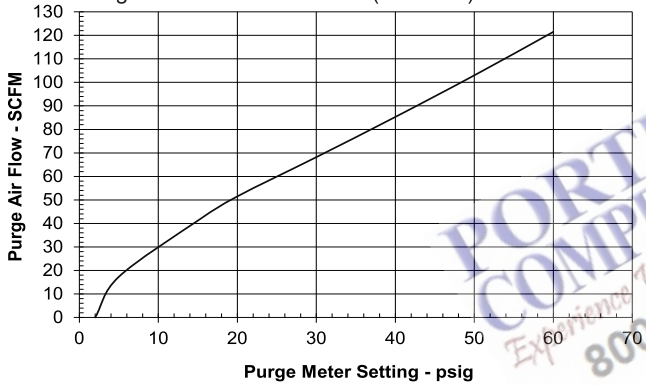

PORTLAND COMPRESSOR
 Experience You Can Depend On
 800-542-8300



Dryer Model: **HLA 800**
 Purge Pressure Setting: **46 psig (4.18bar) @ 130 SCFM**
 Purge Orifice: **7/16" (11.1 mm)**

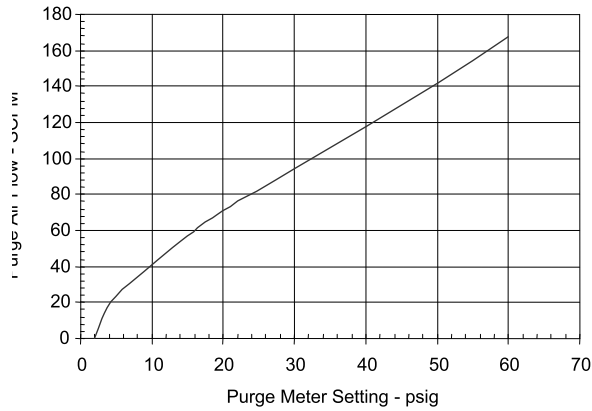

Dryer Model: **HLA 1000**
 Purge Pressure Setting: **43 psig (3.97bar) @ 162 SCFM**
 Purge Orifice: **1/2" (12.7 mm)**

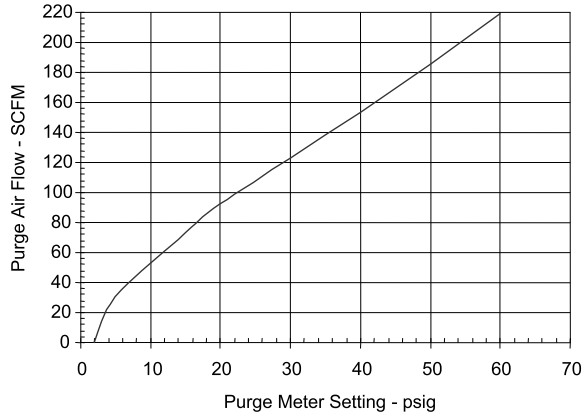

Dryer Model: **HLA 1200**
 Purge Pressure Setting: **41 psig (3.84bar) @ 195 SCFM**
 Purge Orifice: **9/16" (14.2 mm)**

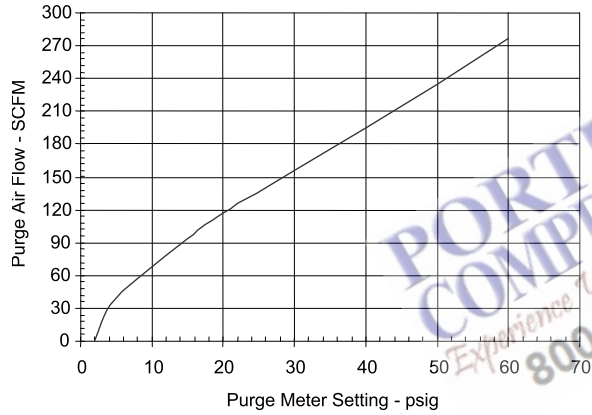

Dryer Model: **HLA 1500**
 Purge Pressure Setting: **41 psig (3.84bar) @ 243 SCFM**
 Purge Orifice: **5/8" (15.8 mm)**

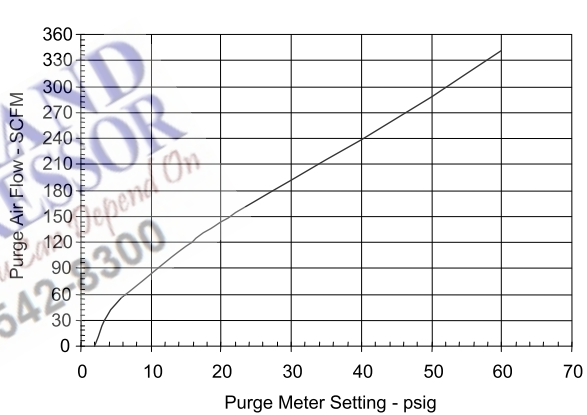

Dryer Model: **HLA 1800**
 Purge Pressure Setting: **51 psig (4.52bar) @ 292 SCFM**
 Purge Orifice: **5/8" (15.8 mm)**

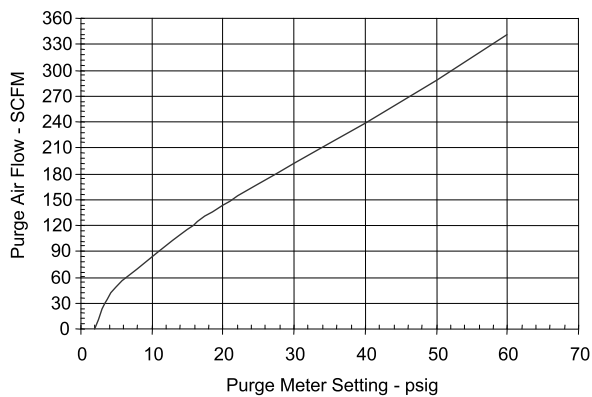

Dryer Model: **HLA 2100**
 Purge Pressure Setting: **40 psig (3.77bar) @ 340 SCFM**
 Purge Orifice: **3/4" (19 mm)**

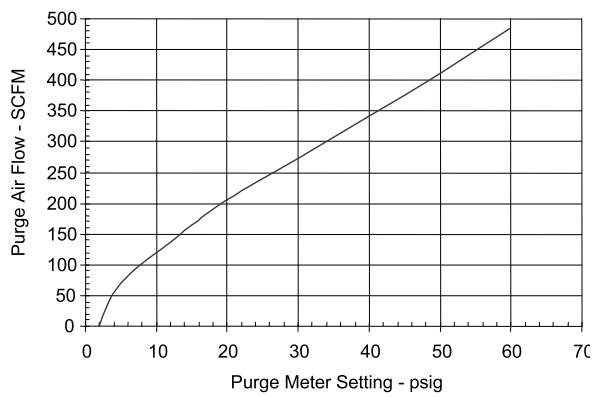

Dryer Model: **HLA 2700**
 Purge Pressure Setting: **53 psig (4.66bar) @ 438 SCFM**
 Purge Orifice: **3/4" (19 mm)**

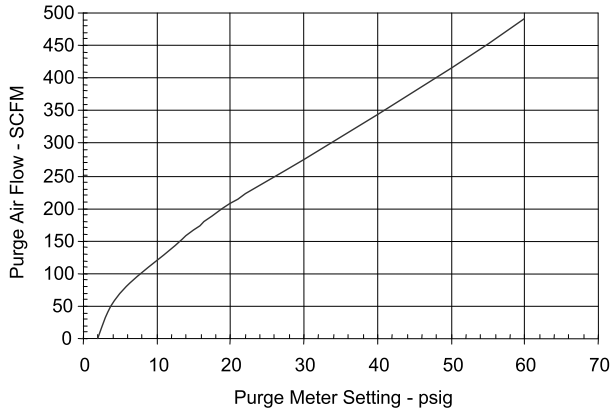

Dryer Model: **HLA 3300**
 Purge Pressure Setting: **47 psig (4.25bar) @ 535 SCFM**
 Purge Orifice: **7/8" (22.2 mm)**

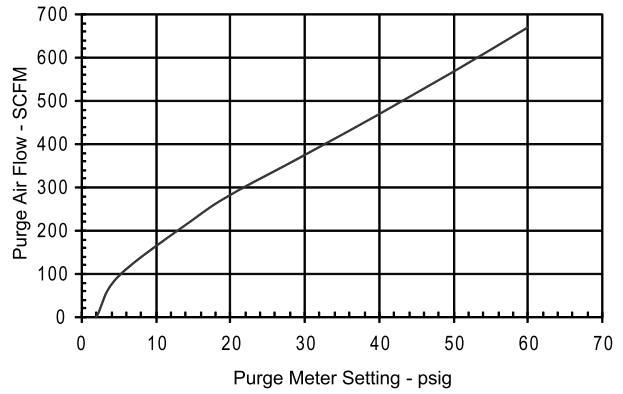

Dryer Model: **HLA 4000**
 Purge Pressure Setting: **44 psig (4.04bar) @ 649 SCFM**
 Purge Orifice: **1" (25.4 mm)**

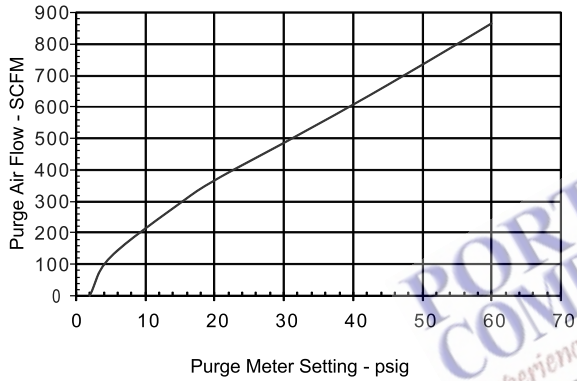

Dryer Model: **HLA 5000**
 Purge Pressure Setting: **56 psig (4.87bar) @ 811 SCFM**
 Purge Orifice: **1" (25.4mm)**

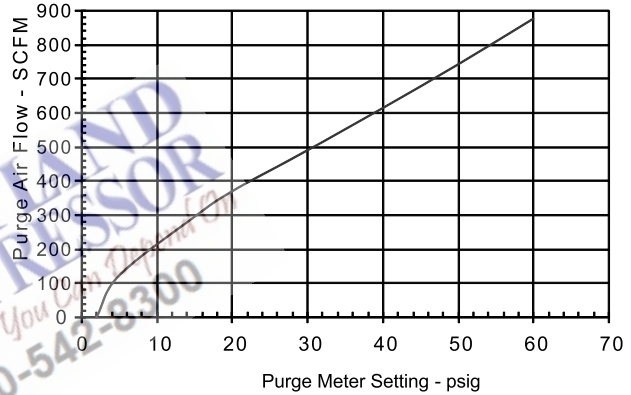

PORTLAND
 COMPRESSOR
 Experience You Can Depend On
 800-542-8300

12.0 GENERAL ARRANGEMENT

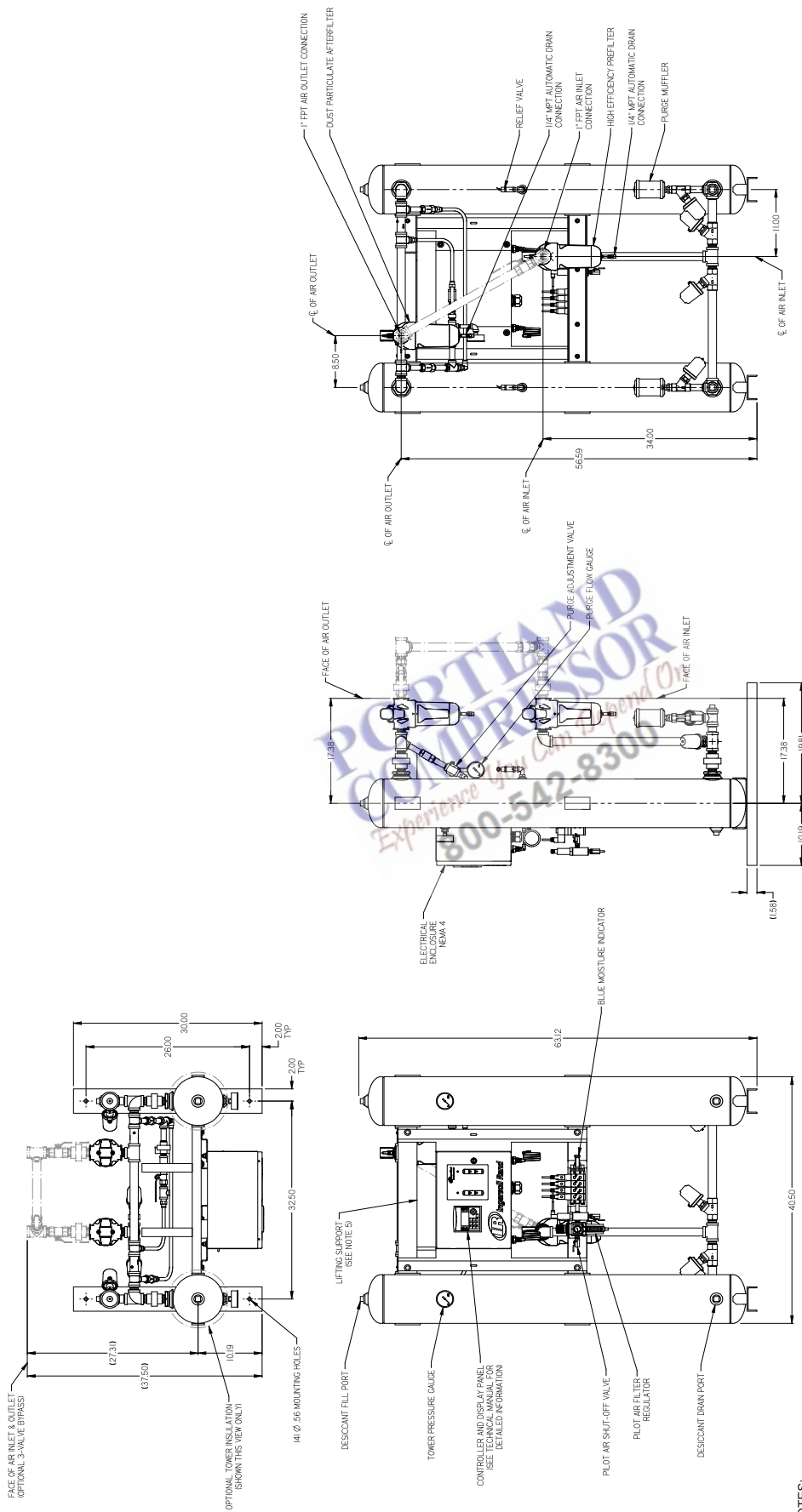

General Arrangement
 Dryer Models: HLA 90-HLA 120
 NEMA 4
 Drawing No.: 47597093

NOTES:

1. Maximum Working Pressure - 150 PSI.
2. Safety Relief Valve Setting - 165 PSI.
3. Pilot Air Lines Not Shown For Clarity.
4. All Wiring is in accordance with the National Electrical Code's latest edition.
5. Dryer to be lifted by lifting support only.
6. Design is depicted for standard model. This drawing does not depict options.
7. The unit dimensions will vary for products configured with options.
8. This drawing is provided for reference purposes only. Nominal dimensional tolerances +/- 1.00"
9. Design and dimensions are subject to change without notice.
10. Location of compressed air inlet & outlet connections may vary based on options selected.

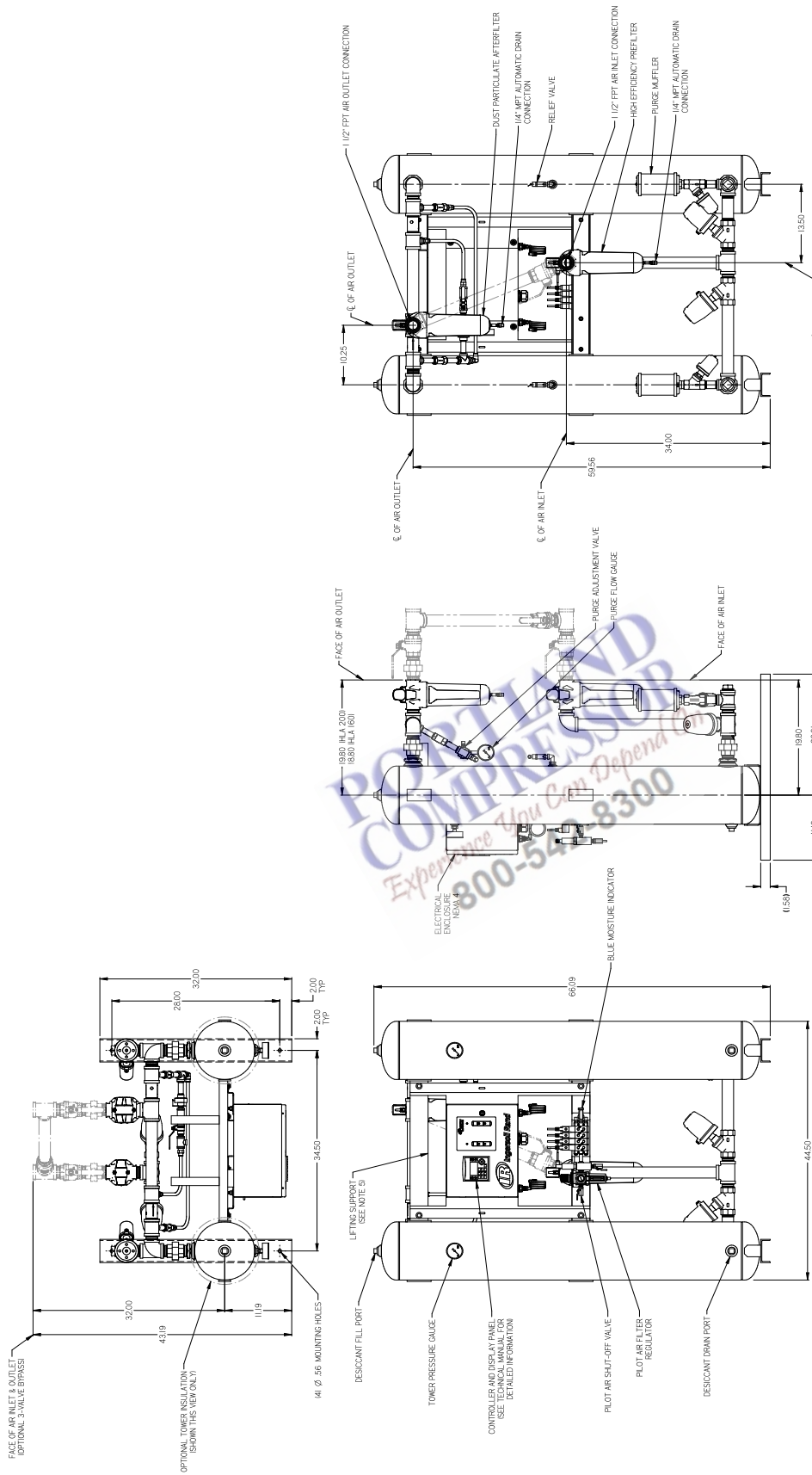

General Arrangement
 Dryer Models: HLA 160 - HLA 200
 NEMA 4
 Drawing No.: 47597094

NOTES:

1. Maximum WORKING PRESSURE - 150 PSI.
2. SAFETY RELIEF VALVE SETTING - 165 PSI.
3. PILOT AIR LINES NOT SHOWN FOR CLARITY.
4. ALL WIRING IS IN ACCORDANCE WITH THE NATIONAL ELECTRICAL CODE'S LATEST EDITION.
5. DRYER TO BE LIFTED BY LIFTING SUPPORT ONLY.
6. DESIGN IS DEPICTED FOR STANDARD MODEL. THIS DRAWING DOES NOT DEPICT OPTIONS.
7. THE UNIT DIMENSIONS WILL VARY FOR PRODUCTS CONFIGURED WITH OPTIONS.
8. THIS DRAWING IS PROVIDED FOR REFERENCE PURPOSES ONLY. NOMINAL DIMENSIONAL TOLERANCES +/- 1.00"
9. DESIGN AND DIMENSIONS ARE SUBJECT TO CHANGE WITHOUT NOTICE.
10. LOCATION OF COMPRESSED AIR INLET & OUTLET CONNECTIONS MAY VARY BASED ON OPTIONS SELECTED.

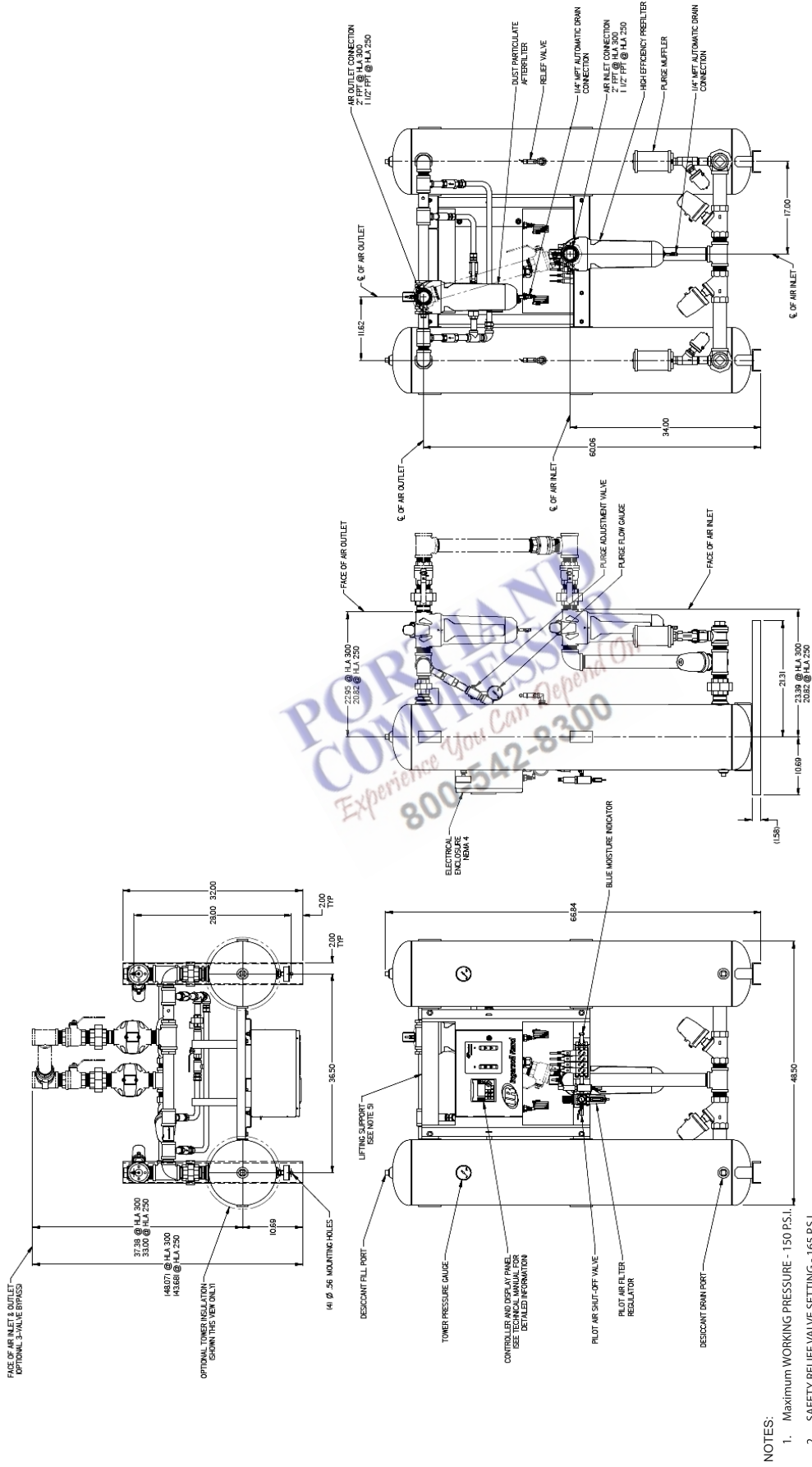

General Arrangement
 Dryer Models: HLA 250 - HLA 300
 NEMA 4
 Drawing No.: 47597095

- NOTES:
1. Maximum Working Pressure - 150 PS.I.
 2. SAFETY RELIEF VALVE SETTING - 165 PS.I.
 3. PILOT AIR LINES NOT SHOWN FOR CLARITY.
 4. ALL WIRING IS IN ACCORDANCE WITH THE NATIONAL ELECTRICAL CODE'S LATEST EDITION.
 5. DRYER TO BE LIFTED BY LIFTING SUPPORT ONLY.
 6. DESIGN IS DEPICTED FOR STANDARD MODEL. THIS DRAWING DOES NOT DEPICT OPTIONS.
 7. THE UNIT DIMENSIONS WILL VARY FOR PRODUCTS CONFIGURED WITH OPTIONS.
 8. THIS DRAWING IS PROVIDED FOR REFERENCE PURPOSES ONLY. NOMINAL DIMENSIONAL TOLERANCES +/- 1.00"
 9. DESIGN AND DIMENSIONS ARE SUBJECT TO CHANGE WITHOUT NOTICE.
 10. LOCATION OF COMPRESSED AIR INLET & OUTLET CONNECTIONS MAY VARY BASED ON OPTIONS SELECTED.

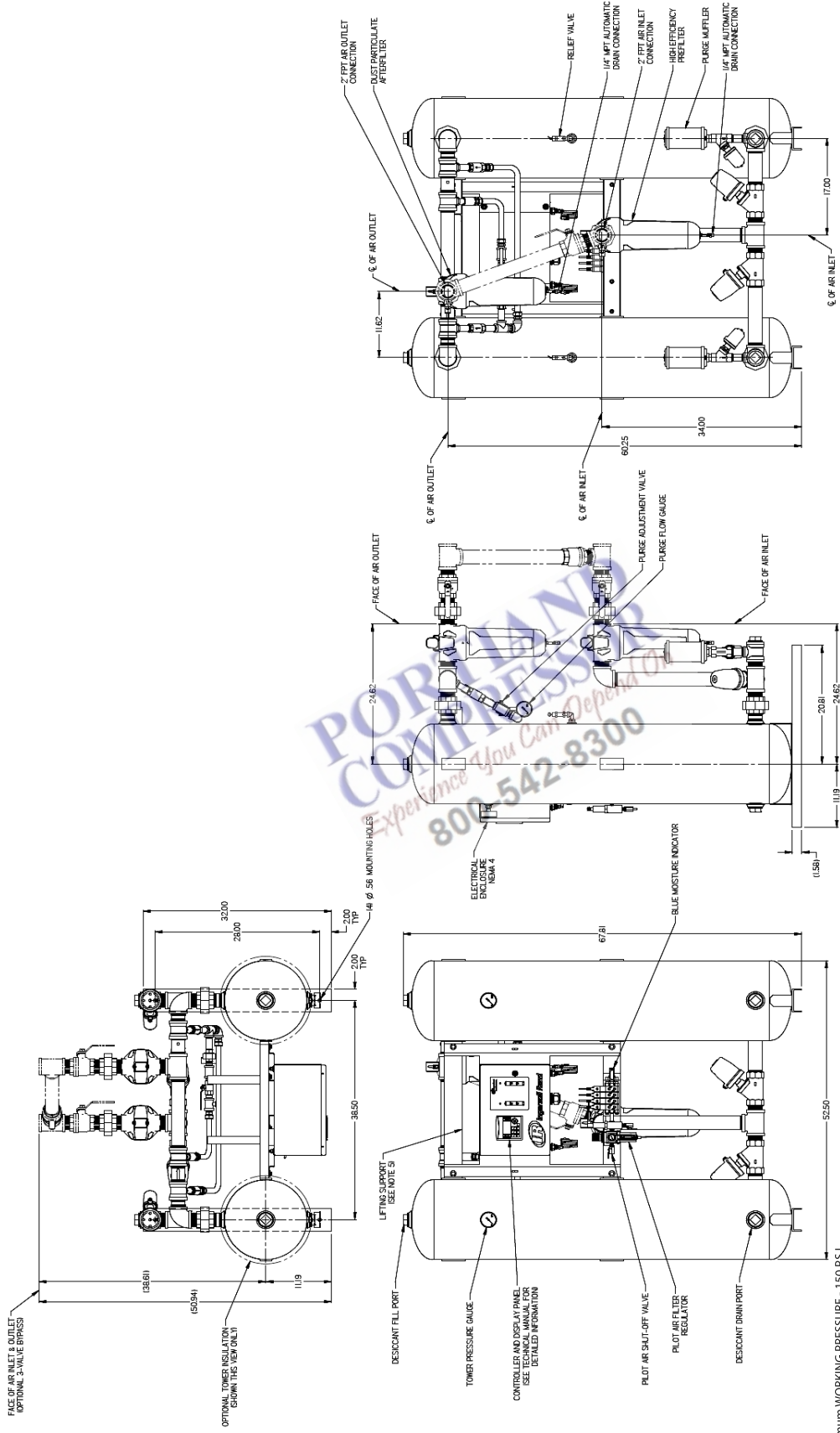

General Arrangement
 Dryer Models: HLA 400
 NEMA 4
 Drawing No.: 47597096

- NOTES:**
1. Maximum Working Pressure - 150 P.S.I.
 2. SAFETY RELIEF VALVE SETTING - 165 P.S.I.
 3. PILOT AIR LINES NOT SHOWN FOR CLARITY.
 4. ALL WIRING IS IN ACCORDANCE WITH THE NATIONAL ELECTRICAL CODE'S LATEST EDITION.
 5. DRYER TO BE LIFTED BY LIFTING SUPPORT ONLY.
 6. DESIGN IS DEPICTED FOR STANDARD MODEL. THIS DRAWING DOES NOT DEPICT OPTIONS.
 7. THE UNIT DIMENSIONS WILL VARY FOR PRODUCTS CONFIGURED WITH OPTIONS.
 8. THIS DRAWING IS PROVIDED FOR REFERENCE PURPOSES ONLY. NOMINAL DIMENSIONAL TOLERANCES +/- 1.00"
 9. DESIGN AND DIMENSIONS ARE SUBJECT TO CHANGE WITHOUT NOTICE.
 10. LOCATION OF COMPRESSED AIR INLET & OUTLET CONNECTIONS MAY VARY BASED ON OPTIONS SELECTED.

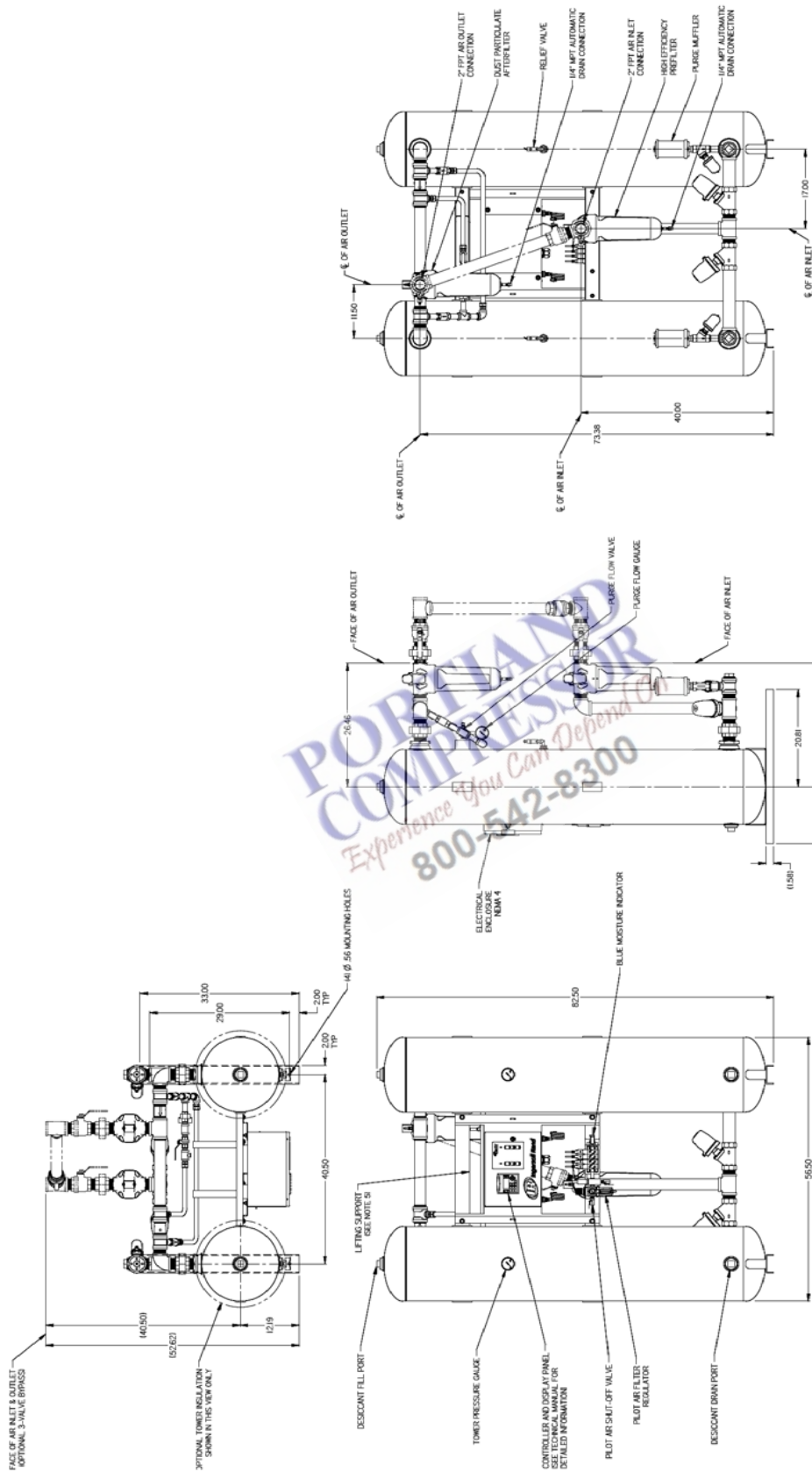

NOTES:

1. Maximum WORKING PRESSURE - 150 PSI.
2. SAFETY RELIEF VALVE SETTING - 165 PSI.
3. PILOT AIR LINES NOT SHOWN FOR CLARITY.
4. ALL WIRING IS IN ACCORDANCE WITH THE NATIONAL ELECTRICAL CODE'S LATEST EDITION.
5. DRYER TO BE LIFTED BY LIFTING SUPPORT ONLY.
6. DESIGN IS DEPICTED FOR STANDARD MODEL. THIS DRAWING DOES NOT DEPICT OPTIONS.
7. THE UNIT DIMENSIONS WILL VARY FOR PRODUCTS CONFIGURED WITH OPTIONS.
8. THIS DRAWING IS PROVIDED FOR REFERENCE PURPOSES ONLY; NOMINAL DIMENSIONAL TOLERANCES +/- 1.00"
9. DESIGN AND DIMENSIONS ARE SUBJECT TO CHANGE WITHOUT NOTICE.
10. LOCATION OF COMPRESSED AIR INLET & OUTLET CONNECTIONS MAY VARY BASED ON OPTIONS SELECTED.

General Arrangement
 Dryer Models: HLA 500 - HLA 600
 NEMA 4
 Drawing No.: 47597097

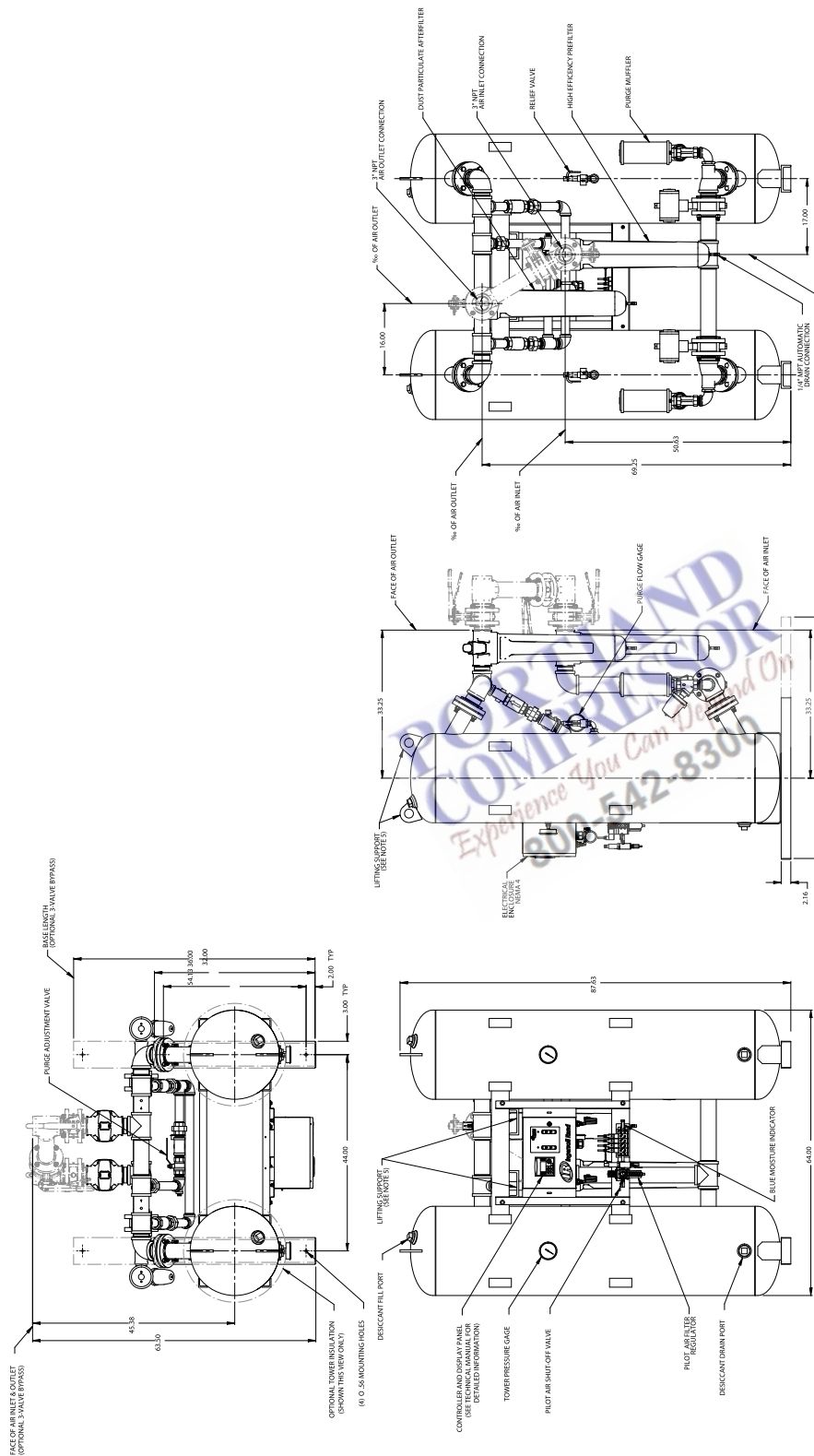

General Arrangement
 Dryer Models: HLA 800 - HLA 1200
 Drawing No.: 47597098

NOTES:

1. Maximum WORKING PRESSURE - 150 P.S.I.
2. SAFETY RELIEF VALVE SETTING - 165 P.S.I.
3. PIURE AIR LINES NOT SHOWN FOR CLARITY.
4. ALL WIRING IS IN ACCORDANCE WITH THE NATIONAL ELECTRICAL CODE'S LATEST EDITION.
5. DRYER TO BE LIFTED BY LIFTING SUPPORT ONLY.
6. DESIGN IS DEPICTED FOR STANDARD MODEL. THIS DRAWING DOES NOT DEPICT OPTIONS.
7. THE UNIT DIMENSIONS WILL VARY FOR PRODUCTS CONFIGURED WITH OPTIONS.
8. THIS DRAWING IS PROVIDED FOR REFERENCE PURPOSES ONLY. NOMINAL DIMENSIONAL TOLERANCES +/- 1.00"
9. DESIGN AND DIMENSIONS ARE SUBJECT TO CHANGE WITHOUT NOTICE.
10. LOCATION OF COMPRESSED AIR INLET & OUTLET CONNECTIONS MAY VARY BASED ON OPTIONS SELECTED.

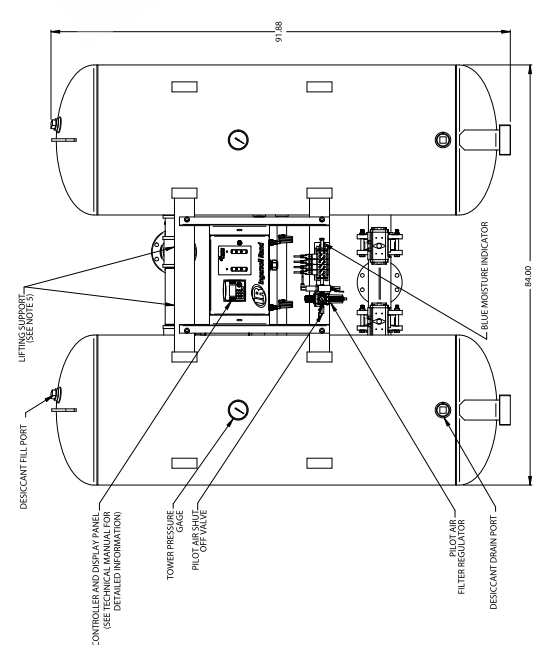
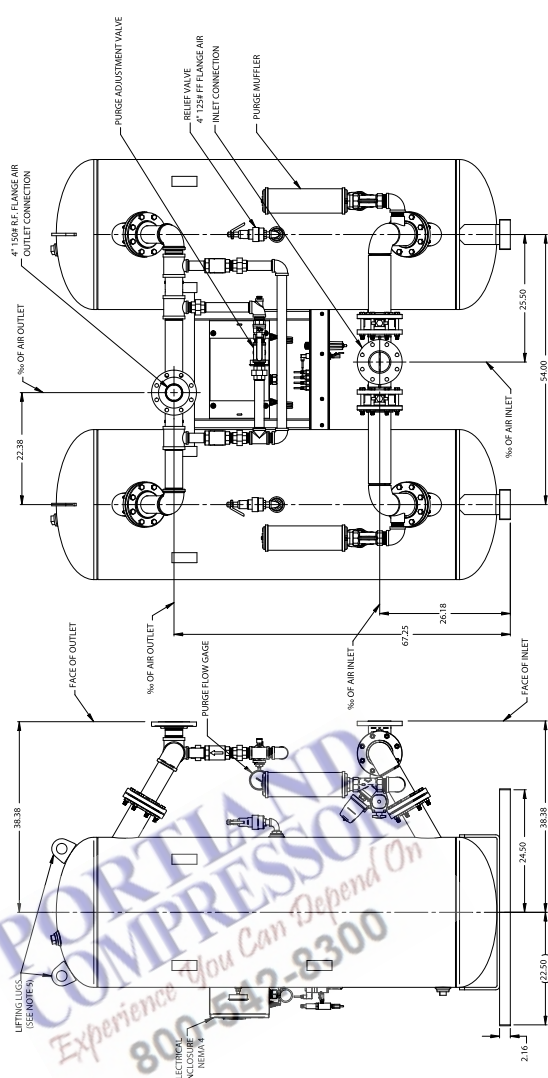
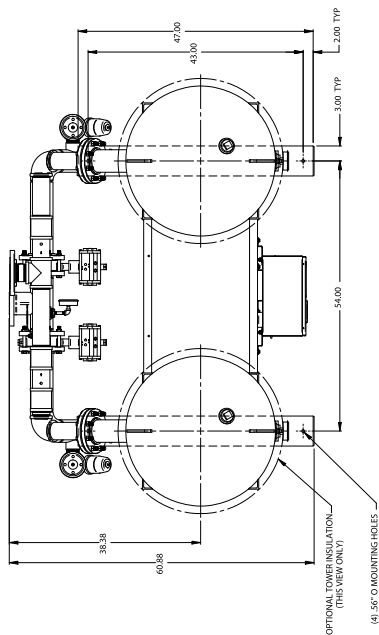

General Arrangement
 Dryer Models: HLA 1800 - HLA 2100
 NEMA 4
 Drawing No.: 47597100

NOTES:

1. Maximum WORKING PRESSURE - 150 P.S.I.
2. SAFETY RELIEF VALVE SETTING - 165 P.S.I.
3. PILOT AIR LINES NOT SHOWN FOR CLARITY.
4. ALL WIRING IS IN ACCORDANCE WITH THE NATIONAL ELECTRICAL CODE'S LATEST EDITION.
5. DRYER TO BE LIFTED BY LIFTING SUPPORT ONLY.
6. DESIGN IS DEPICTED FOR STANDARD MODEL. THIS DRAWING DOES NOT DEPICT OPTIONS.
7. THE UNIT DIMENSIONS WILL VARY FOR PRODUCTS CONFIGURED WITH OPTIONS.
8. THIS DRAWING IS PROVIDED FOR REFERENCE PURPOSES ONLY. NOMINAL DIMENSIONAL TOLERANCES +/- 1.00"
9. DESIGN AND DIMENSIONS ARE SUBJECT TO CHANGE WITHOUT NOTICE.
10. LOCATION OF COMPRESSED AIR INLET & OUTLET CONNECTIONS MAY VARY BASED ON OPTIONS SELECTED.
11. FILTER PACKAGES SHIPPED SEPARATELY. FILTER PIPING SUPPORT, IF REQUIRED, TO BE SUPPLIED BY CUSTOMER.

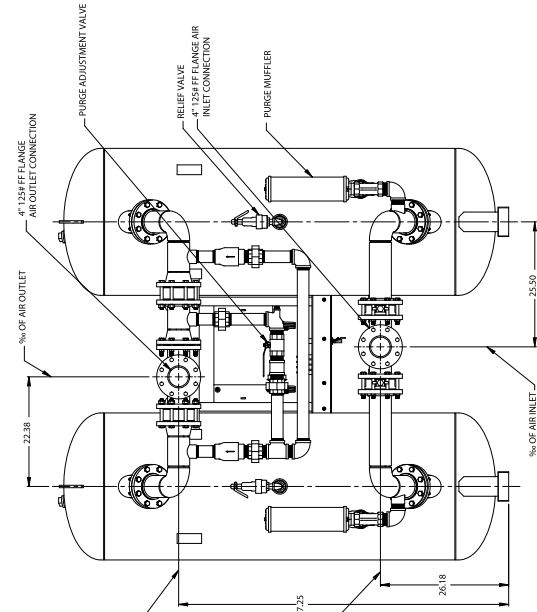
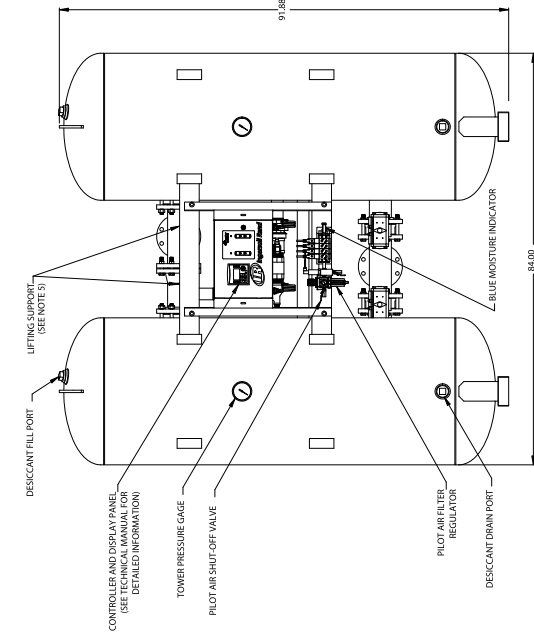
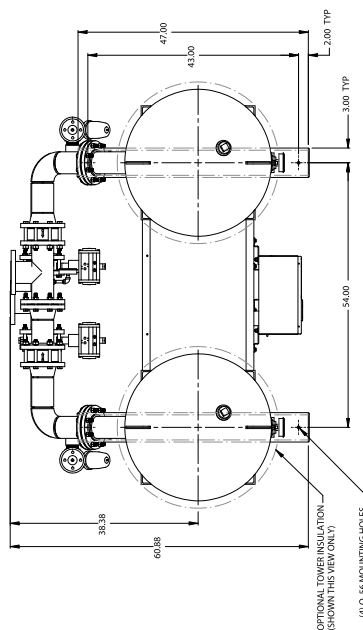

NOTES:

1. Maximum WORKING PRESSURE - 150 P.S.I.
2. SAFETY RELIEF VALVE SETTING - 165 P.S.I.
3. PILOT AIR LINES NOT SHOWN FOR CLARITY.
4. ALL WIRING IS IN ACCORDANCE WITH THE NATIONAL ELECTRICAL CODE'S LATEST EDITION.
5. DRYER TO BE LIFTED BY LIFTING SUPPORT ONLY.
6. DESIGN IS DEPICTED FOR STANDARD MODEL. THIS DRAWING DOES NOT DEPICT OPTIONS.
7. THE UNIT DIMENSIONS WILL VARY FOR PRODUCTS CONFIGURED WITH OPTIONS.
8. THIS DRAWING IS PROVIDED FOR REFERENCE PURPOSES ONLY. NOMINAL DIMENSIONAL TOLERANCES +/- 1.00"
9. DESIGN AND DIMENSIONS ARE SUBJECT TO CHANGE WITHOUT NOTICE.
10. LOCATION OF COMPRESSED AIR INLET & OUTLET CONNECTIONS MAY VARY BASED ON OPTIONS SELECTED.

General Arrangement
 Dryer Models: HLA 2700
 Drawing No.: 47597101

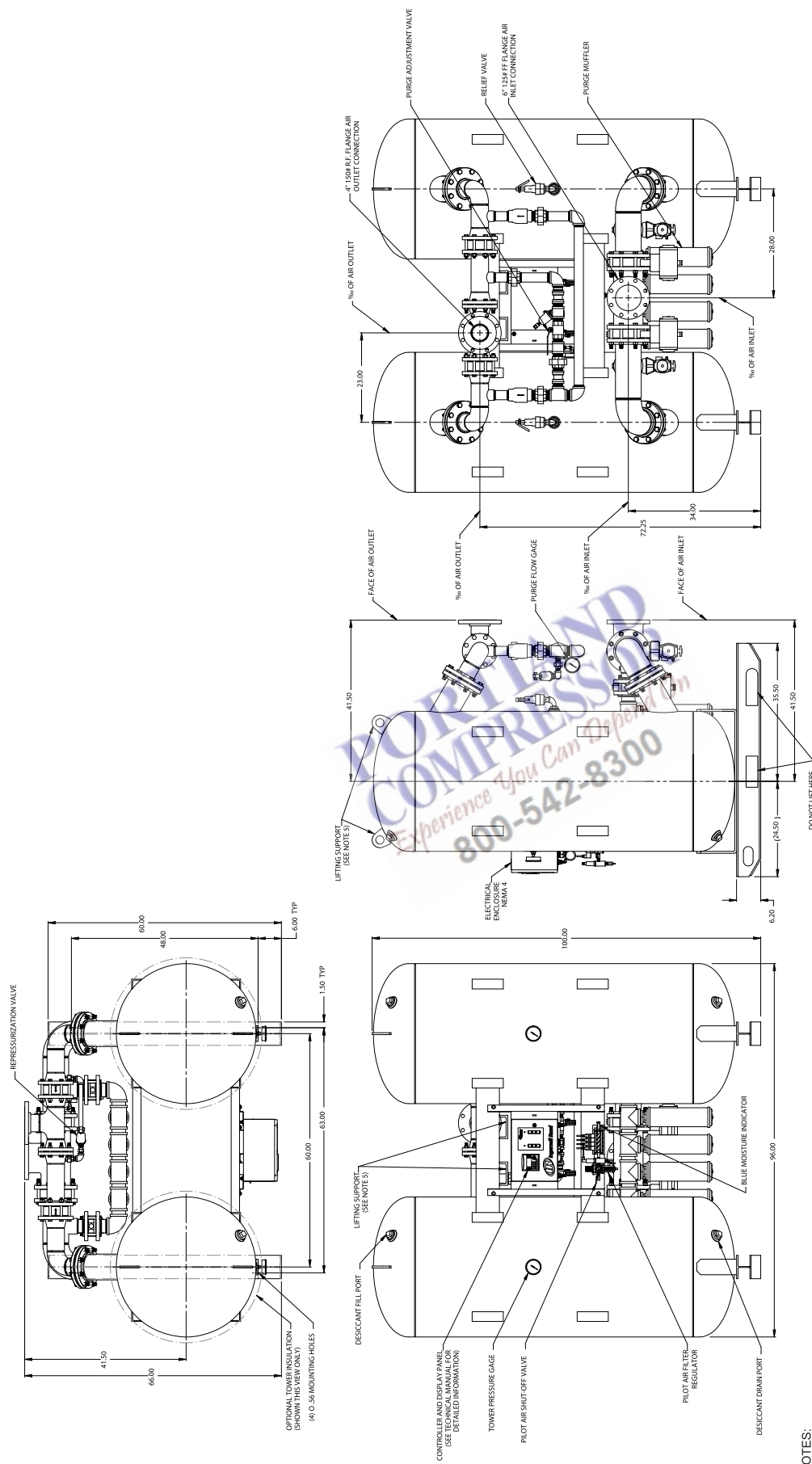

General Arrangement
 Dryer Models: HLA 3300 - HLA 4000
 Drawing No.: 47597102

- NOTES:
1. Maximum Working Pressure - 150 P.S.I.
 2. SAFETY RELIEF VALVE SETTING - 165 P.S.I.
 3. PILOT AIR LINES NOT SHOWN FOR CLARITY.
 4. ALL WIRING IS IN ACCORDANCE WITH THE NATIONAL ELECTRICAL CODE'S LATEST EDITION.
 5. DRYER TO BE LIFTED BY LIFTING SUPPORT ONLY.
 6. DESIGN IS DEPICTED FOR STANDARD MODEL. THIS DRAWING DOES NOT DEPICT OPTIONS.
 7. THE UNIT DIMENSIONS WILL VARY FOR PRODUCTS CONFIGURED WITH OPTIONS.
 8. THIS DRAWING IS PROVIDED FOR REFERENCE PURPOSES ONLY. NOMINAL DIMENSIONAL TOLERANCES +/- 1.00"
 9. DESIGN AND DIMENSIONS ARE SUBJECT TO CHANGE WITHOUT NOTICE.
 10. LOCATION OF COMPRESSED AIR INLET & OUTLET CONNECTIONS MAY VARY BASED ON OPTIONS SELECTED.

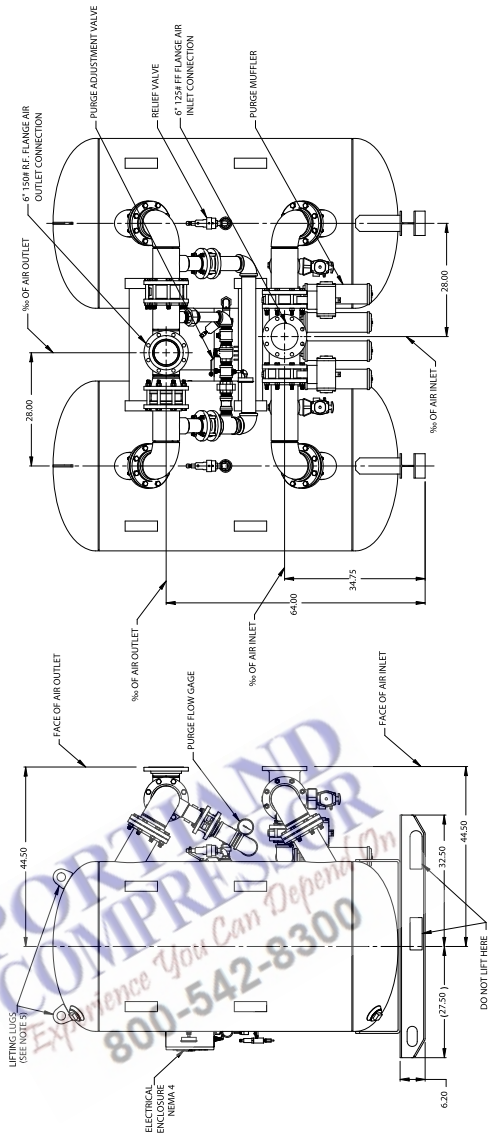
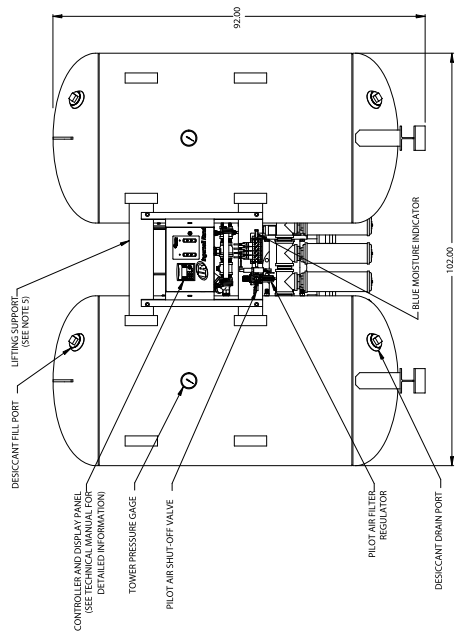
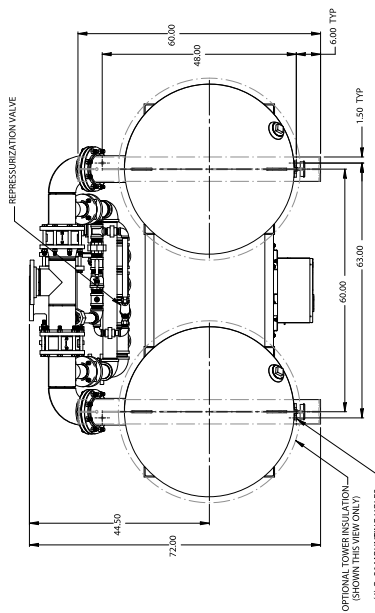

NOTES:

1. Maximum WORKING PRESSURE - 150 P.S.I.
2. SAFETY RELIEF VALVE SETTING - 165 P.S.I.
3. PILOT AIR LINES NOT SHOWN FOR CLARITY.
4. ALL WIRING IS IN ACCORDANCE WITH THE NATIONAL ELECTRICAL CODE'S LATEST EDITION.
5. DRYER TO BE LIFTED BY LIFTING SUPPORT ONLY.
6. DESIGN IS DEPICTED FOR STANDARD MODEL. THIS DRAWING DOES NOT DEPICT OPTIONS.
7. THE UNIT DIMENSIONS WILL VARY FOR PRODUCTS CONFIGURED WITH OPTIONS.
8. THIS DRAWING IS PROVIDED FOR REFERENCE PURPOSES ONLY. NOMINAL DIMENSIONAL TOLERANCES +/- 1.00"
9. DESIGN AND DIMENSIONS ARE SUBJECT TO CHANGE WITHOUT NOTICE.
10. LOCATION OF COMPRESSED AIR INLET & OUTLET CONNECTIONS MAY VARY BASED ON OPTIONS SELECTED.

General Arrangement
 Dryer Models: HLA 5000
 Drawing No.: 47597103

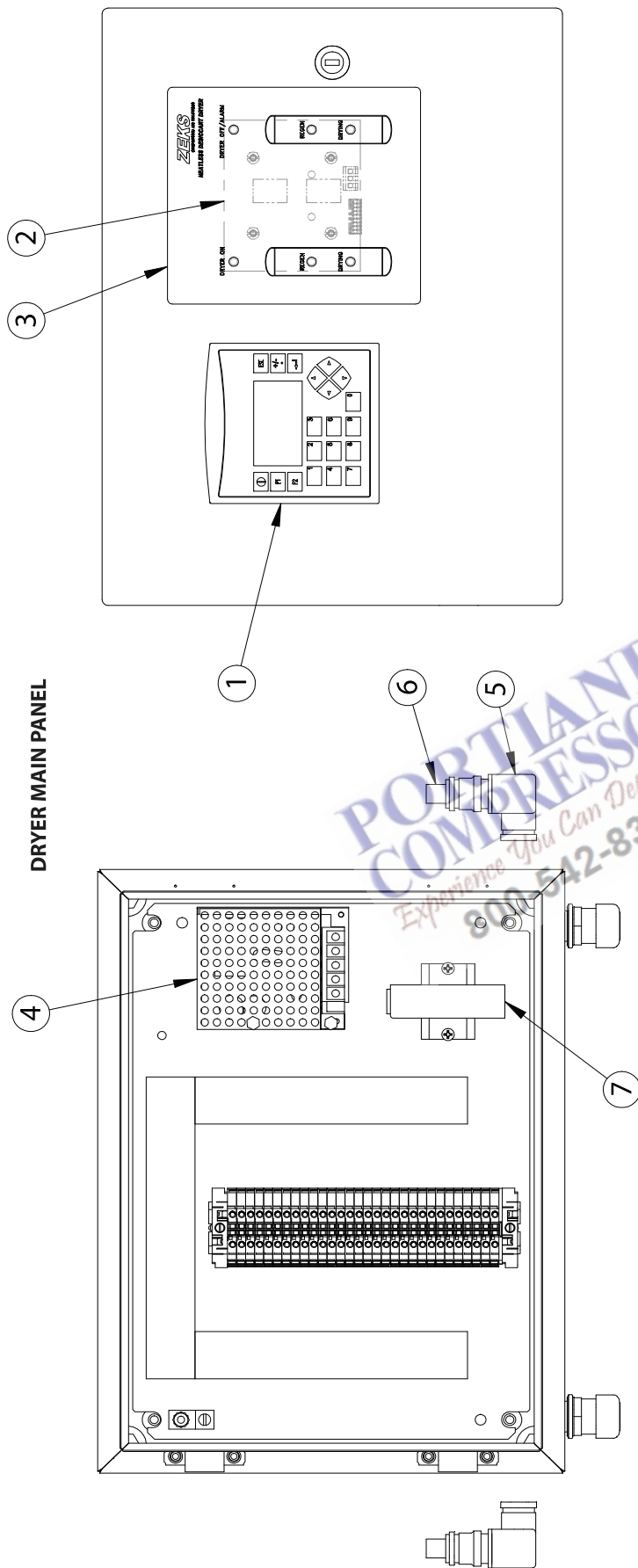

ITEM NO.	ITEM NO.	DESCRIPTION
1	47606394001	Dryer Controller with Program (Dryer Model and Serial Number must be provided when ordering)
2	38053682	Display Board, Panel
3	23540198	Overlay, Controller
4	47587161001	Power Supply, 5VDC/24VDC
5	47757093001	Transducer Cable, 6FT, DIN FORM A 18MM (Fail-To-Shift Optioned Units Only)
6	47757092001	Transducer, 0-300 PSIA DIN FORM A 18MM (Fail-To-Shift Optioned Units Only)
7	23174022	Repeater, Current Loop 4-20mA (4-20mA PDP Output Optioned Units Only)

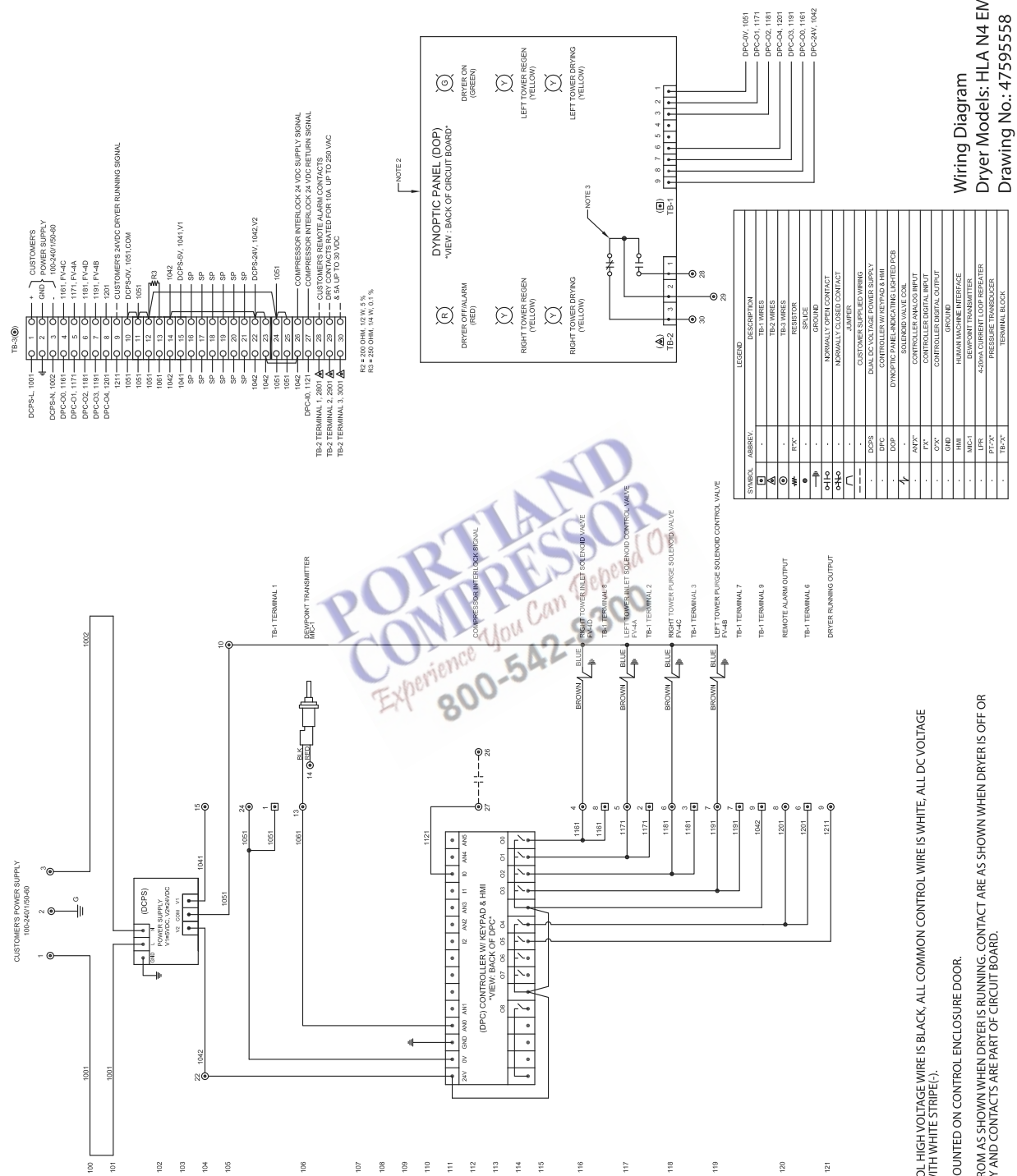

Wiring Diagram
Dryer Models: HLA N4 EMS
Drawing No.: 47595558

14.0 FLOW DIAGRAM

- LEGEND**
- DRYING AIR FLOW
 - REGENERATING AIR FLOW
 - DRYER AIR PIPING
 - CONTROL AIR PIPING
 - - - OPTIONAL AIR PIPING
- DPI-2** PREFILTER ELEMENT DIFFERENTIAL PRESSURE INDICATOR
DPI-3 AFTERFILTER ELEMENT DIFFERENTIAL PRESSURE INDICATOR
DR-1 CONTROL AIR FILTER REGULATOR DRAIN
DR-2 PREFILTER DRAIN
DR-3 AFTERFILTER DRAIN (NOTE 2)
EXH-1 LEFT TOWER PURGE MUFFLER
EXH-2 RIGHT TOWER PURGE MUFFLER
FLT-2 PREFILTER - HIGH EFFICIENCY
FLT-3 AFTERFILTER - DUST PARTICULATE
FR-1 CONTROL AIR FILTER WITH REGULATOR AND BUILT IN GAUGE
FO-1 PURGE ORIFICE
FO-4 REPRESSURIZATION ORIFICE (NOTE 3)
FV-1A LEFT TOWER INLET VALVE
FV-2A RIGHT TOWER INLET VALVE
FV-1B LEFT TOWER PURGE VALVE
FV-2B RIGHT TOWER PURGE VALVE
FV-1C LEFT TOWER OUTLET CHECK VALVE
FV-2C RIGHT TOWER OUTLET CHECK VALVE
FV-1P LEFT TOWER PURGE CHECK VALVE
FV-2P RIGHT TOWER PURGE CHECK VALVE
FV-4A LEFT TOWER INLET SOLENOID CONTROL VALVE
FV-4B LEFT TOWER PURGE SOLENOID CONTROL VALVE
FV-4C RIGHT TOWER INLET SOLENOID CONTROL VALVE
FV-4D RIGHT TOWER PURGE SOLENOID CONTROL VALVE
FV-5 REPRESSURIZATION VALVE (NOTE 3)
FV-5A REPRESSURIZATION SHUTTLE VALVE (NOTE 3)
FX-1(A) FLOW DISTRIBUTION SCREEN (4 PLACES)
HCV-1 PURGE FLOW METERING VALVE
HCV-2 CONTROL AIR SHUTOFF VALVE
HCV-3 EMS TRANSMITTER SHUTOFF VALVE (OPTIONAL)
HCV-4 EMS BLEED VALVE (OPTIONAL)
HCV-5 DRYER BYPASS VALVE (3 PLACES) (OPTIONAL)
MIC-1 BLUE MOISTURE INDICATOR
MI-4 ENERGY MANAGEMENT SYSTEM (EMS) TRANSMITTER (OPTIONAL)
PI-1 LEFT TOWER PRESSURE GAUGE
PI-2 RIGHT TOWER PRESSURE GAUGE
PI-3 PURGE PRESSURE GAUGE
PT-1 LEFT TOWER FTS PRESSURE TRANSDUCER (OPTIONAL)
PT-2 RIGHT TOWER FTS PRESSURE TRANSDUCER (OPTIONAL)
PSV-1 LEFT TOWER SAFETY RELIEF VALVE
PSV-2 RIGHT TOWER SAFETY RELIEF VALVE

NOTES:
 1. SYMBOLS AND TAGS BASED ON ISA STANDARDS S5.1 - S5.5.
 2. HIGH OPERATING PRESSURE UNITS ARE FINISHED WITH A BALL VALVE FOR DR-3.
 3. FV-5, FO-4, AND FV-5A ARE STANDARD ON HIGH PRESSURE UNITS AND -80/-100F PDP UNITS.

Flow Diagram
 Dryer Models: HLA 90 - 600
 STD W/ OPTIONS
 Drawing No.: 47604295

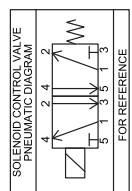
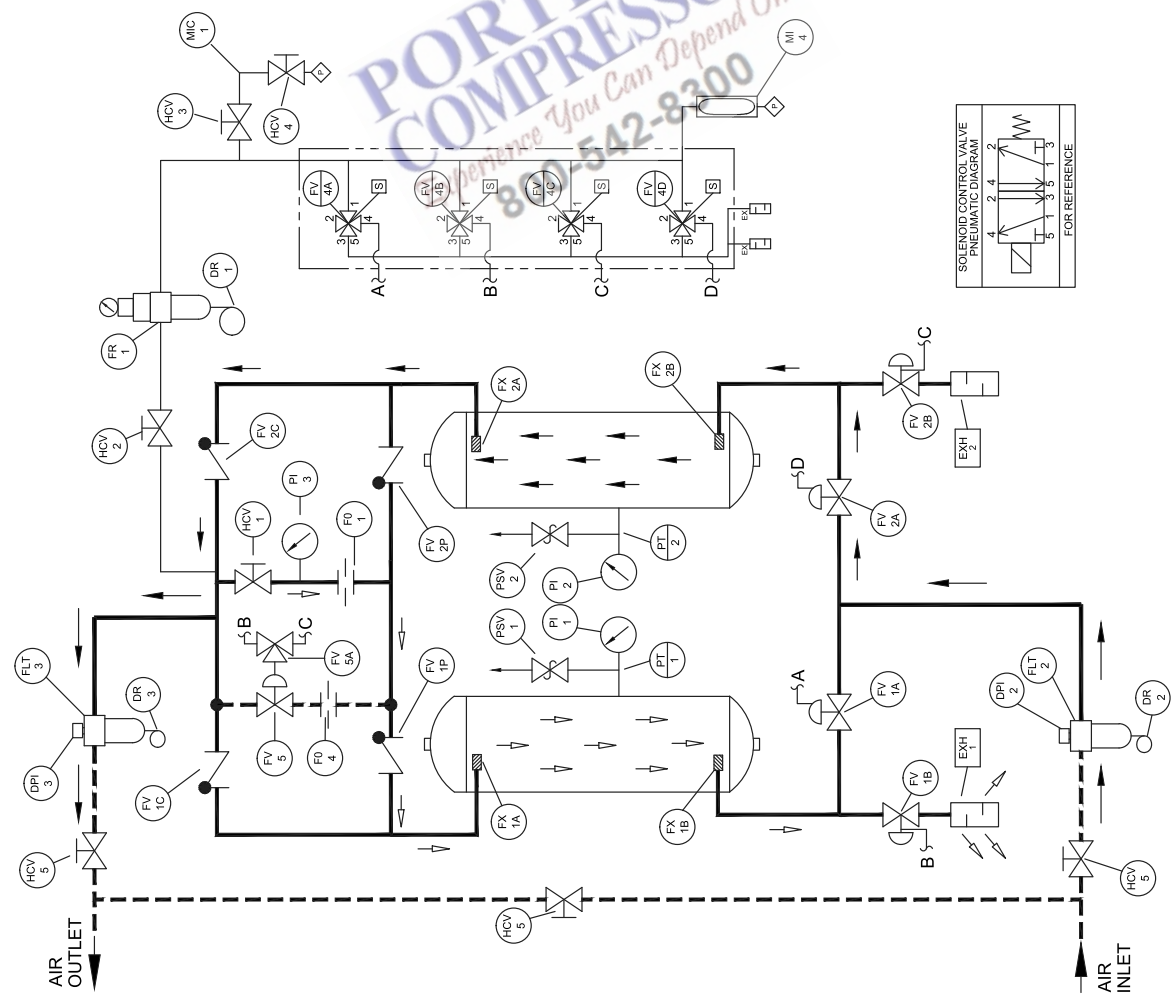

- LEGEND**
- DRYING AIR FLOW
 - REGENERATING AIR FLOW
 - DRYER AIR PIPING
 - CONTROL AIR PIPING
 - OPTIONAL AIR PIPING

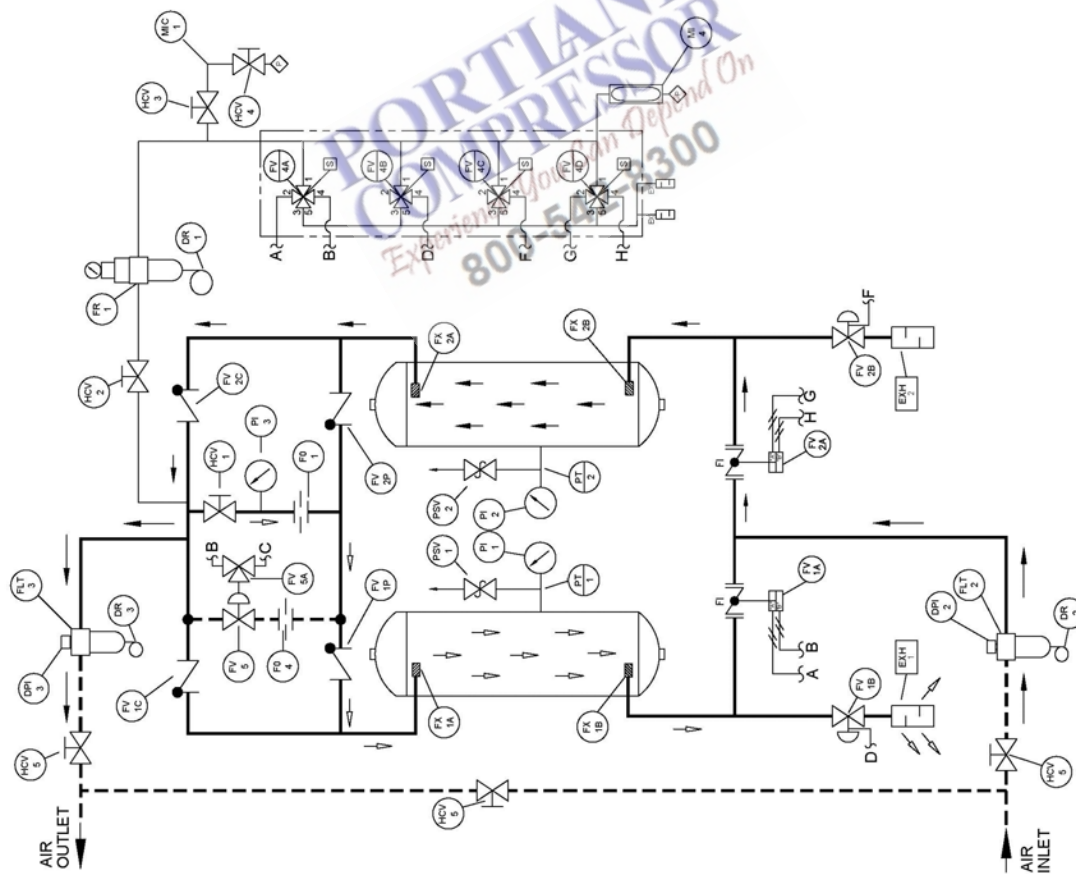

- DRP-2 PREFILTER ELEMENT DIFFERENTIAL PRESSURE INDICATOR
- DRP-3 PREFILTER ELEMENT DIFFERENTIAL PRESSURE INDICATOR
- DR-1 CONTROL AIR FILTER REGULATOR DRAIN
- DR-2 AFTERFILTER DRAIN (NOTE 2)
- DR-3 AFTERFILTER DRAIN (NOTE 2)
- EXH-1 LEFT TOWER PURGE MUFFLER
- EXH-2 RIGHT TOWER PURGE MUFFLER
- FLT-2 PREFILTER - HIGH EFFICIENCY
- FLT-3 AFTERFILTER - DUST PARTICULATE
- FR-1 CONTROL AIR FILTER WITH REGULATOR AND BUILT IN GAUGE
- FR-2 PURGE SERVICE
- FR-3 PURGE SERVICE
- FR-4 PURGE SERVICE (NOTE 3)
- FV-1A RIGHT TOWER INLET VALVE
- FV-2A LEFT TOWER INLET VALVE
- FV-2B RIGHT TOWER PURGE VALVE
- FV-1B LEFT TOWER PURGE VALVE
- FV-1C RIGHT TOWER OUTLET CHECK VALVE
- FV-2C LEFT TOWER OUTLET CHECK VALVE
- FV-1P RIGHT TOWER PURGE CHECK VALVE
- FV-2P LEFT TOWER PURGE CHECK VALVE
- FV-4A LEFT TOWER INLET SOLENOID CONTROL VALVE
- FV-4B RIGHT TOWER INLET SOLENOID CONTROL VALVE
- FV-4C LEFT TOWER PURGE SOLENOID CONTROL VALVE
- FV-4D RIGHT TOWER PURGE SOLENOID CONTROL VALVE
- FV-5 RIGHT TOWER INLET SOLENOID CONTROL VALVE
- FV-5A REPRESSURIZATION VALVE (NOTE 3)
- FX-XX FLOW DISTRIBUTION SCREEN (4 PLACES)
- HCV-1 PURGE FLOW METERING VALVE
- HCV-2 CONTROL AIR SHUTOFF VALVE
- HCV-3 EMS TRANSMITTER SHUTOFF VALVE (OPTIONAL)
- HCV-4 PURGE BYPASS VALVE (OPTIONAL)
- HCV-5 DRYER BYPASS VALVE (3 PLACES) (OPTIONAL)
- M-4 BLUE MOISTURE INDICATOR
- MIC-1 ENERGY MANAGEMENT SYSTEM (EMS) TRANSMITTER (OPTIONAL)
- PI-1 LEFT TOWER PRESSURE GAUGE
- PI-2 RIGHT TOWER PRESSURE GAUGE
- PH-3 PURGE PRESSURE GAUGE
- PT-1 LEFT TOWER FTS PRESSURE TRANSDUCER (OPTIONAL)
- PT-2 RIGHT TOWER FTS PRESSURE TRANSDUCER (OPTIONAL)
- PSV-1 LEFT TOWER SAFETY RELIEF VALVE
- PSV-2 RIGHT TOWER SAFETY RELIEF VALVE

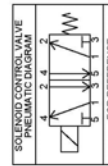

- NOTES:**
1. SYMBOLS AND TAGS BASED ON ISA STANDARDS S5.1 - S5.5.
 2. HIGH OPERATING PRESSURE UNITS ARE FINISHED WITH A BALL VALVE FOR DR-3.
 3. FV-5, FV-4, AND FV-5A ARE STANDARD ON HIGH PRESSURE UNITS AND -80/-100F PDP UNITS.
 4. WHEN VIEWING DUAL ACTING ACTUATOR FACING PORTS, PORT A IS THE LEFT PORT AND PORT B IS THE RIGHT PORT

Flow Diagram
 Dryer Models: HLA 800 -1500
 STD W/ OPTIONS
 Drawing No.: 47634153

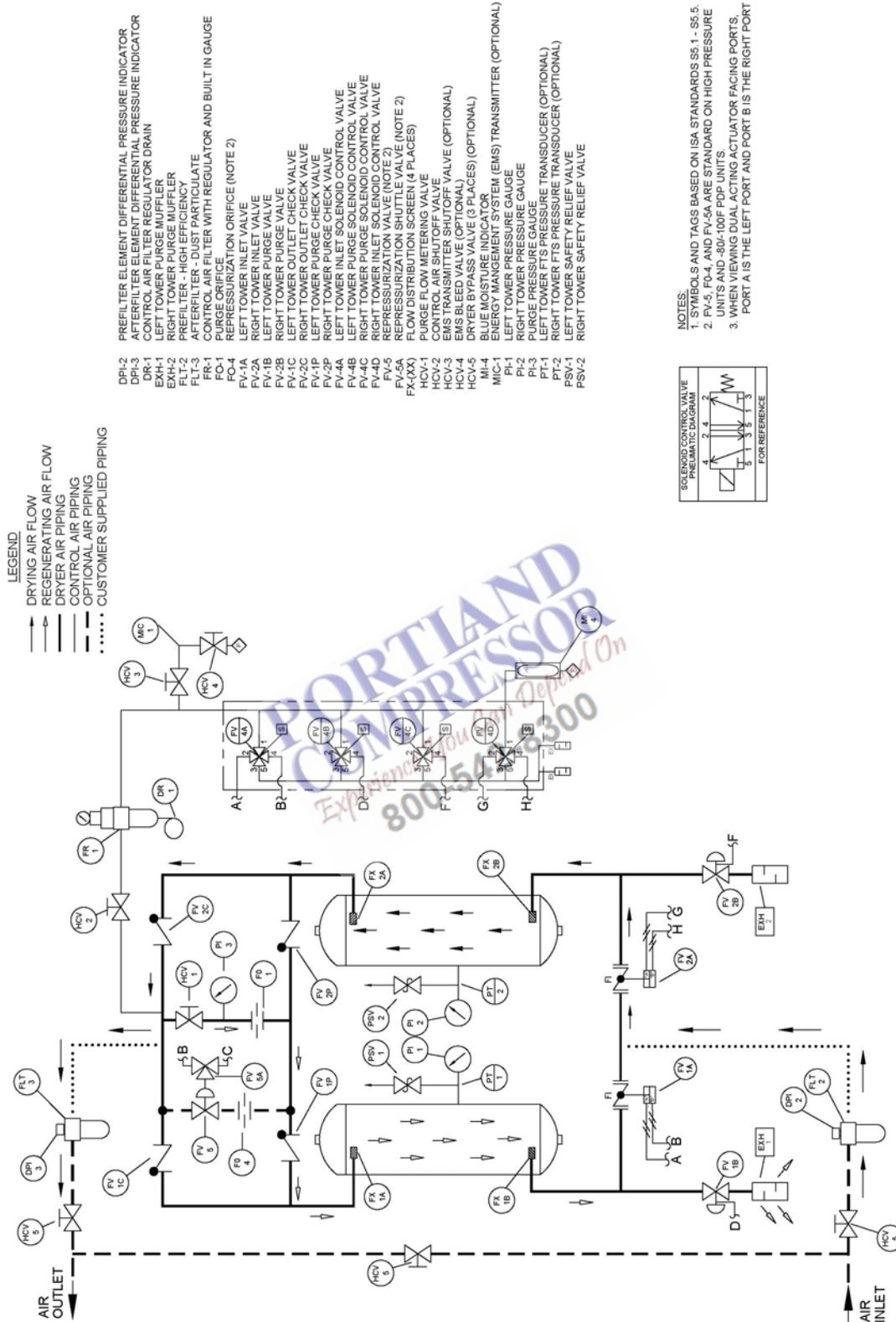

- NOTES:**
1. SYMBOLS AND TAGS BASED ON ISA STANDARDS S5.1 - S5.5.
 2. FV-5, FV-4, AND FV-5A ARE STANDARD ON HIGH PRESSURE UNITS AND -80/-100F PDP UNITS.
 3. WHEN VIEWING DUAL ACTING ACTUATOR FACING PORTS, PORT A IS THE LEFT PORT AND PORT B IS THE RIGHT PORT

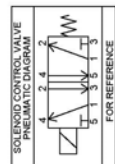

Flow Diagram
 Dryer Models: HLA 1800 - 2700
 STD W/ OPTIONS
 Drawing No.: 47634154

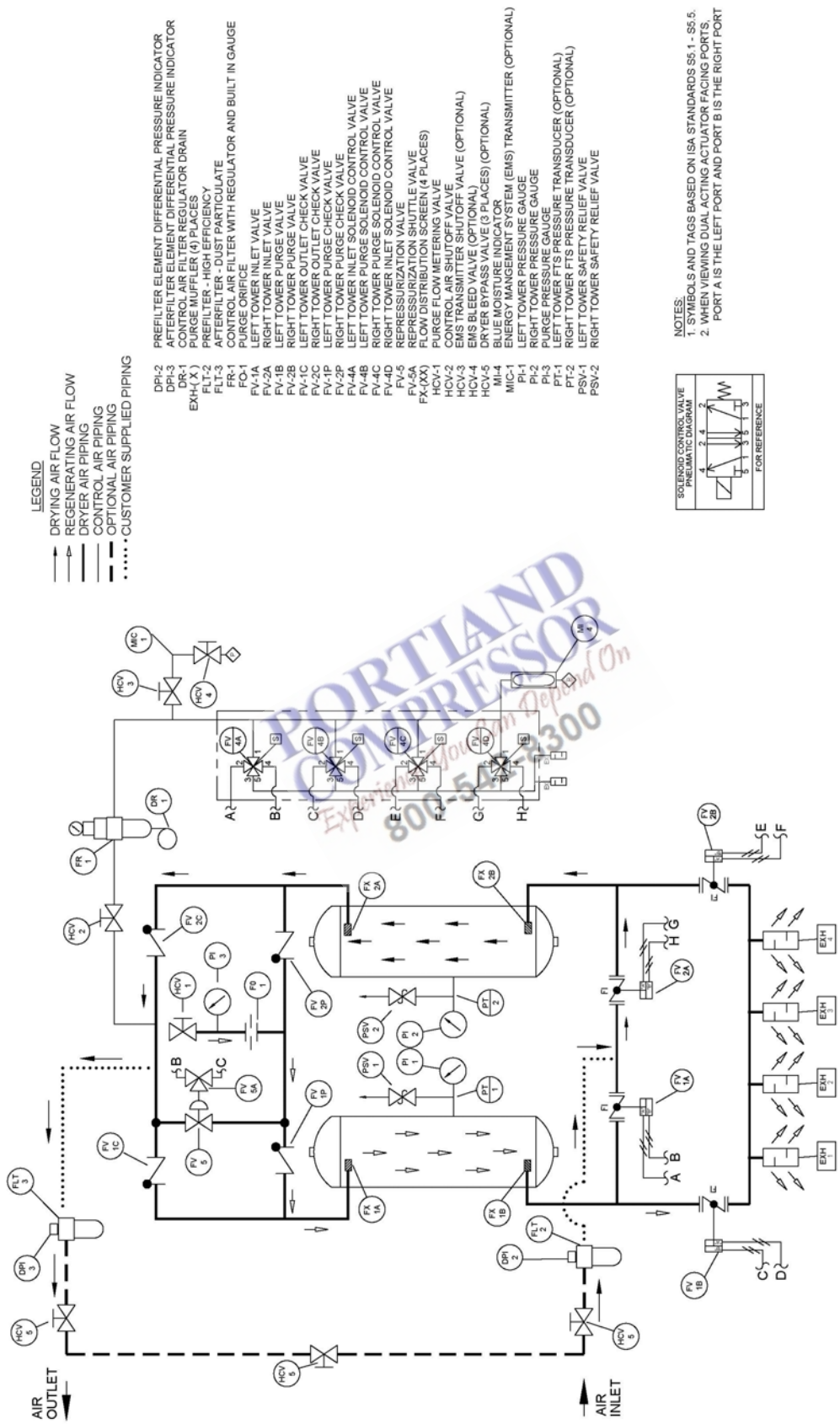

- LEGEND**
- DRYING AIR FLOW
 - REGENERATING AIR FLOW
 - DRYER AIR PIPING
 - CONTROL AIR PIPING
 - OPTIONAL AIR PIPING
 - CUSTOMER SUPPLIED PIPING

- DPI-2 PREFILTER ELEMENT DIFFERENTIAL PRESSURE INDICATOR
- DR-3 AFTERFILTER ELEMENT DIFFERENTIAL PRESSURE INDICATOR
- DR-4 AFTERFILTER ELEMENT DIFFERENTIAL PRESSURE INDICATOR
- DR-5 AFTERFILTER ELEMENT DIFFERENTIAL PRESSURE INDICATOR
- DR-6 AFTERFILTER ELEMENT DIFFERENTIAL PRESSURE INDICATOR
- DR-7 AFTERFILTER ELEMENT DIFFERENTIAL PRESSURE INDICATOR
- DR-8 AFTERFILTER ELEMENT DIFFERENTIAL PRESSURE INDICATOR
- DR-9 AFTERFILTER ELEMENT DIFFERENTIAL PRESSURE INDICATOR
- DR-10 AFTERFILTER ELEMENT DIFFERENTIAL PRESSURE INDICATOR
- DR-11 AFTERFILTER ELEMENT DIFFERENTIAL PRESSURE INDICATOR
- DR-12 AFTERFILTER ELEMENT DIFFERENTIAL PRESSURE INDICATOR
- DR-13 AFTERFILTER ELEMENT DIFFERENTIAL PRESSURE INDICATOR
- DR-14 AFTERFILTER ELEMENT DIFFERENTIAL PRESSURE INDICATOR
- DR-15 AFTERFILTER ELEMENT DIFFERENTIAL PRESSURE INDICATOR
- DR-16 AFTERFILTER ELEMENT DIFFERENTIAL PRESSURE INDICATOR
- DR-17 AFTERFILTER ELEMENT DIFFERENTIAL PRESSURE INDICATOR
- DR-18 AFTERFILTER ELEMENT DIFFERENTIAL PRESSURE INDICATOR
- DR-19 AFTERFILTER ELEMENT DIFFERENTIAL PRESSURE INDICATOR
- DR-20 AFTERFILTER ELEMENT DIFFERENTIAL PRESSURE INDICATOR
- DR-21 AFTERFILTER ELEMENT DIFFERENTIAL PRESSURE INDICATOR
- DR-22 AFTERFILTER ELEMENT DIFFERENTIAL PRESSURE INDICATOR
- DR-23 AFTERFILTER ELEMENT DIFFERENTIAL PRESSURE INDICATOR
- DR-24 AFTERFILTER ELEMENT DIFFERENTIAL PRESSURE INDICATOR
- DR-25 AFTERFILTER ELEMENT DIFFERENTIAL PRESSURE INDICATOR
- DR-26 AFTERFILTER ELEMENT DIFFERENTIAL PRESSURE INDICATOR
- DR-27 AFTERFILTER ELEMENT DIFFERENTIAL PRESSURE INDICATOR
- DR-28 AFTERFILTER ELEMENT DIFFERENTIAL PRESSURE INDICATOR
- DR-29 AFTERFILTER ELEMENT DIFFERENTIAL PRESSURE INDICATOR
- DR-30 AFTERFILTER ELEMENT DIFFERENTIAL PRESSURE INDICATOR
- DR-31 AFTERFILTER ELEMENT DIFFERENTIAL PRESSURE INDICATOR
- DR-32 AFTERFILTER ELEMENT DIFFERENTIAL PRESSURE INDICATOR
- DR-33 AFTERFILTER ELEMENT DIFFERENTIAL PRESSURE INDICATOR
- DR-34 AFTERFILTER ELEMENT DIFFERENTIAL PRESSURE INDICATOR
- DR-35 AFTERFILTER ELEMENT DIFFERENTIAL PRESSURE INDICATOR
- DR-36 AFTERFILTER ELEMENT DIFFERENTIAL PRESSURE INDICATOR
- DR-37 AFTERFILTER ELEMENT DIFFERENTIAL PRESSURE INDICATOR
- DR-38 AFTERFILTER ELEMENT DIFFERENTIAL PRESSURE INDICATOR
- DR-39 AFTERFILTER ELEMENT DIFFERENTIAL PRESSURE INDICATOR
- DR-40 AFTERFILTER ELEMENT DIFFERENTIAL PRESSURE INDICATOR
- DR-41 AFTERFILTER ELEMENT DIFFERENTIAL PRESSURE INDICATOR
- DR-42 AFTERFILTER ELEMENT DIFFERENTIAL PRESSURE INDICATOR
- DR-43 AFTERFILTER ELEMENT DIFFERENTIAL PRESSURE INDICATOR
- DR-44 AFTERFILTER ELEMENT DIFFERENTIAL PRESSURE INDICATOR
- DR-45 AFTERFILTER ELEMENT DIFFERENTIAL PRESSURE INDICATOR
- DR-46 AFTERFILTER ELEMENT DIFFERENTIAL PRESSURE INDICATOR
- DR-47 AFTERFILTER ELEMENT DIFFERENTIAL PRESSURE INDICATOR
- DR-48 AFTERFILTER ELEMENT DIFFERENTIAL PRESSURE INDICATOR
- DR-49 AFTERFILTER ELEMENT DIFFERENTIAL PRESSURE INDICATOR
- DR-50 AFTERFILTER ELEMENT DIFFERENTIAL PRESSURE INDICATOR
- DR-51 AFTERFILTER ELEMENT DIFFERENTIAL PRESSURE INDICATOR
- DR-52 AFTERFILTER ELEMENT DIFFERENTIAL PRESSURE INDICATOR
- DR-53 AFTERFILTER ELEMENT DIFFERENTIAL PRESSURE INDICATOR
- DR-54 AFTERFILTER ELEMENT DIFFERENTIAL PRESSURE INDICATOR
- DR-55 AFTERFILTER ELEMENT DIFFERENTIAL PRESSURE INDICATOR
- DR-56 AFTERFILTER ELEMENT DIFFERENTIAL PRESSURE INDICATOR
- DR-57 AFTERFILTER ELEMENT DIFFERENTIAL PRESSURE INDICATOR
- DR-58 AFTERFILTER ELEMENT DIFFERENTIAL PRESSURE INDICATOR
- DR-59 AFTERFILTER ELEMENT DIFFERENTIAL PRESSURE INDICATOR
- DR-60 AFTERFILTER ELEMENT DIFFERENTIAL PRESSURE INDICATOR
- DR-61 AFTERFILTER ELEMENT DIFFERENTIAL PRESSURE INDICATOR
- DR-62 AFTERFILTER ELEMENT DIFFERENTIAL PRESSURE INDICATOR
- DR-63 AFTERFILTER ELEMENT DIFFERENTIAL PRESSURE INDICATOR
- DR-64 AFTERFILTER ELEMENT DIFFERENTIAL PRESSURE INDICATOR
- DR-65 AFTERFILTER ELEMENT DIFFERENTIAL PRESSURE INDICATOR
- DR-66 AFTERFILTER ELEMENT DIFFERENTIAL PRESSURE INDICATOR
- DR-67 AFTERFILTER ELEMENT DIFFERENTIAL PRESSURE INDICATOR
- DR-68 AFTERFILTER ELEMENT DIFFERENTIAL PRESSURE INDICATOR
- DR-69 AFTERFILTER ELEMENT DIFFERENTIAL PRESSURE INDICATOR
- DR-70 AFTERFILTER ELEMENT DIFFERENTIAL PRESSURE INDICATOR
- DR-71 AFTERFILTER ELEMENT DIFFERENTIAL PRESSURE INDICATOR
- DR-72 AFTERFILTER ELEMENT DIFFERENTIAL PRESSURE INDICATOR
- DR-73 AFTERFILTER ELEMENT DIFFERENTIAL PRESSURE INDICATOR
- DR-74 AFTERFILTER ELEMENT DIFFERENTIAL PRESSURE INDICATOR
- DR-75 AFTERFILTER ELEMENT DIFFERENTIAL PRESSURE INDICATOR
- DR-76 AFTERFILTER ELEMENT DIFFERENTIAL PRESSURE INDICATOR
- DR-77 AFTERFILTER ELEMENT DIFFERENTIAL PRESSURE INDICATOR
- DR-78 AFTERFILTER ELEMENT DIFFERENTIAL PRESSURE INDICATOR
- DR-79 AFTERFILTER ELEMENT DIFFERENTIAL PRESSURE INDICATOR
- DR-80 AFTERFILTER ELEMENT DIFFERENTIAL PRESSURE INDICATOR
- DR-81 AFTERFILTER ELEMENT DIFFERENTIAL PRESSURE INDICATOR
- DR-82 AFTERFILTER ELEMENT DIFFERENTIAL PRESSURE INDICATOR
- DR-83 AFTERFILTER ELEMENT DIFFERENTIAL PRESSURE INDICATOR
- DR-84 AFTERFILTER ELEMENT DIFFERENTIAL PRESSURE INDICATOR
- DR-85 AFTERFILTER ELEMENT DIFFERENTIAL PRESSURE INDICATOR
- DR-86 AFTERFILTER ELEMENT DIFFERENTIAL PRESSURE INDICATOR
- DR-87 AFTERFILTER ELEMENT DIFFERENTIAL PRESSURE INDICATOR
- DR-88 AFTERFILTER ELEMENT DIFFERENTIAL PRESSURE INDICATOR
- DR-89 AFTERFILTER ELEMENT DIFFERENTIAL PRESSURE INDICATOR
- DR-90 AFTERFILTER ELEMENT DIFFERENTIAL PRESSURE INDICATOR
- DR-91 AFTERFILTER ELEMENT DIFFERENTIAL PRESSURE INDICATOR
- DR-92 AFTERFILTER ELEMENT DIFFERENTIAL PRESSURE INDICATOR
- DR-93 AFTERFILTER ELEMENT DIFFERENTIAL PRESSURE INDICATOR
- DR-94 AFTERFILTER ELEMENT DIFFERENTIAL PRESSURE INDICATOR
- DR-95 AFTERFILTER ELEMENT DIFFERENTIAL PRESSURE INDICATOR
- DR-96 AFTERFILTER ELEMENT DIFFERENTIAL PRESSURE INDICATOR
- DR-97 AFTERFILTER ELEMENT DIFFERENTIAL PRESSURE INDICATOR
- DR-98 AFTERFILTER ELEMENT DIFFERENTIAL PRESSURE INDICATOR
- DR-99 AFTERFILTER ELEMENT DIFFERENTIAL PRESSURE INDICATOR
- DR-100 AFTERFILTER ELEMENT DIFFERENTIAL PRESSURE INDICATOR

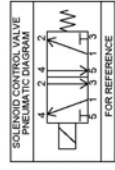

- NOTES:**
1. SHOWN SOLID AND TAGS BASED ON ISA STANDARDS SS 1 - SS 5.
 2. WHEN VIEWING DUAL ACTING ACTUATOR PORTS PORT A IS THE LEFT PORT AND PORT B IS THE RIGHT PORT

Flow Diagram
 Dryer Models: HLA 3300 - 5000
 STD W/ OPTIONS
 Drawing No.: 47634155

15.0 REPLACEMENT PARTS

FLOW DIAGRAM REFERENCE	DESCRIPTION	HLA90 1H00AA	HLA120 1H00AA	HLA160 1H00AA	HLA200 1H00AA	"QTY/ UNIT"	SPARES		
							1	2	3
MI-4	BLUE MOISTURE INDICATOR (BMI)	38054284	38054284	38054284	38054284	1			
	DESICCANT	NOTE 1	NOTE 1	NOTE 1	NOTE 1	NOTE 1			
	DISPLAY BOARD, PANEL	38053682	38053682	38053682	38053682	1			
	DRYER CONTROLLER TYPE 4 WITH DESICCANT PROGRAM (Dryer model and serial number must be provided with order to ensure proper configuration).	47606394001	47606394001	47606394001	47606394001	1			
FR-1	ELEMENT, CONTROL AIR FILTER REGULATOR	15299662	15299662	15299662	15299662	1	1	1	2
FLT-2	ELEMENT, PREFILTER - HIGH EFFICIENCY	24242091	24242166	24242224	24242224	1	1	1	2
FLT-3	ELEMENT, AFTERFILTER - DUST PARTICULATE	24242083	24242141	24242208	24242208	1	1	1	2
DPI-2, DPI-3	GAUGE, DIFFERENTIAL PRESSURE, FILTER	24335051	24335051	24335051	24335051	2			
PI-1, PI-2, PI-3	GAUGE, PRESSURE, TOWER/PURGE	38053153	38053153	38053153	38053153	3			
DR-2, DR-3	INTERNAL DRAIN, FILTER	24335028	24335028	24335028	24335028	2			
EXH-1, EXH-2	MUFFLER, TOWER PURGE	38446514	38446514	38054524	38054524	2	2	2	2
	OVERLAY, DISPLAY BOARD	23540198	23540198	23540198	23540198	1			
	POWER SUPPLY	47587161001	47587161001	47587161001	47587161001	1	1	1	1
FX-1A, FX-2A	RETAINER, DESICCANT SCREEN, UPPER MANIFOLD	38446779	38446779	38446779	38054557	2			
FX-1B, FX-2B	RETAINER, DESICCANT SCREEN, LOWER MANIFOLD	38446779	38446779	38054557	38054557	2			
FV-1A, FV-2A	VALVE, TOWER INLET	47590666001	47590666001	47590668001	47590668001	2			
FV-1B, FV-2B	VALVE, TOWER PURGE	47590665001	47590665001	47590667001	47590667001	2			
HCV-1	VALVE, PURGE FLOW METERING	38052148	38052148	38052148	38052148	1			
HCV-2, HCV-3, HCV-4	VALVE, CONTROL AIR, SHUTOFF/BLEED	38054086	38054086	38054086	38054086	3			
FV-1P, FV-2P	VALVE, CHECK, TOWER PURGE	47787971002	47787971002	47787971002	47787971002	2			
FV-1C, FV-2C	VALVE, CHECK, TOWER OUTLET	38052999	38052999	38052999	38054441	2			
PSV-1, PSV-2	VALVE, SAFETY/RELIEF, TOWER	38053294	38053294	38053294	38053294	2			
FV-4A, FV-4B, FV-4C, FV-4D	VALVE, SOLENOID, CONTROL AIR	47606405001	47606405001	47606405001	47606405001	4			

NOTE 1: Refer to the Desiccant Fill Chart in this Technical Manual: SECTION 9, MAINTENANCE AND SYSTEM CHECK SPARES: Quantity recommended be kept on-hand for maintenance or repair.

CLASS 1: Minimum quantity retained - Where interruptions in service are acceptable.

CLASS 2: Average quantity retained - Where some interruptions in service are acceptable.

CLASS 3: Maximum quantity retained - Where interruptions in service are unacceptable.

FLOW DIAGRAM REFERENCE	DESCRIPTION	HLA250 1H00AA	HLA300 1H00AA	HLA400 1H00AA	HLA500 1H00AA	"QTY/ UNIT"	SPARES		
							1	2	3
MI-4	BLUE MOISTURE INDICATOR (BMI)	38054284	38054284	38054284	38054284	1			
	DESICCANT	NOTE 1	NOTE 1	NOTE 1	NOTE 1	NOTE 1			
	DISPLAY BOARD, PANEL	38053682	38053682	38053682	38053682	1			
	DRYER CONTROLLER TYPE 4 WITH DESICCANT PROGRAM (Dryer model and serial number must be provided with order to ensure proper configuration).	47606394001	47606394001	47606394001	47606394001	1			
FR-1	ELEMENT, CONTROL AIR FILTER REGULATOR	15299662	15299662	15299662	15299662	1	1	1	2
FLT-2	ELEMENT, PREFILTER - HIGH EFFICIENCY	24242273	24242315	24242356	24242398	1	1	1	2
FLT-3	ELEMENT, AFTERFILTER - DUST PARTICULATE	24242265	24242307	24242349	24242380	1	1	1	2
DPI-2, DPI-3	GAUGE, DIFFERENTIAL PRESSURE, FILTER	24335051	24335051	24335051	24335051	2			
PI-1, PI-2, PI-3	GAUGE, PRESSURE, TOWER/PURGE	38053153	38053153	38053153	38053153	3			
DR-2, DR-3	INTERNAL DRAIN, FILTER	24335028	24335028	24335028	24335028	2			
EXH-1, EXH-2	MUFFLER, TOWER PURGE	38054524	38054524	38054524	38054524	2	2	2	2
	OVERLAY, DISPLAY BOARD	23540198	23540198	23540198	23540198	1			
	POWER SUPPLY	47587161001	47587161001	47587161001	47587161001	1	1	1	1
FX-1A, FX-2A	RETAINER, DESICCANT SCREEN, UPPER MANIFOLD	38054557	38054557	38053237	38054573	2			
FX-1B, FX-2B	RETAINER, DESICCANT SCREEN, LOWER MANIFOLD	38054557	38053237	38053237	38054573	2			
FV-1A, FV-2A	VALVE, TOWER INLET	47590668001	47590670001	47590670001	47590670001	2			
FV-1B, FV-2B	VALVE, TOWER PURGE	47590667001	47590667001	47590667001	47590667001	2			
HCV-1	VALVE, PURGE FLOW METERING	38054516	38054516	38054516	38054516	1			
HCV-2, HCV-3, HCV-4	VALVE, CONTROL AIR, SHUTOFF/BLEED	38054086	38054086	38054086	38054086	3			
FV-1P, FV-2P	VALVE, CHECK, TOWER PURGE	47787971003	47787971003	47787971003	47787971003	2			
FV-1C, FV-2C	VALVE, CHECK, TOWER OUTLET	38054441	38054441	38054458	38054458	2			
PSV-1, PSV-2	VALVE, SAFETY/RELIEF, TOWER	38053294	38053294	23642432	23642432	2			
FV-4A, FV-4B, FV-4C, FV-4D	VALVE, SOLENOID, CONTROL AIR	47606405001	47606405001	47606405001	47606405001	4			

NOTE 1: Refer to the Desiccant Fill Chart in this Technical Manual: SECTION 9, MAINTENANCE AND SYSTEM CHECK SPARES: Quantity recommended be kept on-hand for maintenance or repair.

CLASS 1: Minimum quantity retained - Where interruptions in service are acceptable.

CLASS 2: Average quantity retained - Where some interruptions in service are acceptable.

CLASS 3: Maximum quantity retained - Where interruptions in service are unacceptable.

FLOW DIAGRAM REFERENCE	DESCRIPTION	HLA600 1H00AA	HLA800 1H00AA	HLA1000 1H00AA	HLA1200 1H00AA	"QTY/ UNIT"	SPARES		
							1	2	3
MI-4	BLUE MOISTURE INDICATOR (BMI)	38054284	38054284	38054284	38054284	1			
	DESICCANT	NOTE 1	NOTE 1	NOTE 1	NOTE 1	NOTE 1			
	DISPLAY BOARD, PANEL	38053682	38053682	38053682	38053682	1			
	DRYER CONTROLLER TYPE 4 WITH DESICCANT PROGRAM (Dryer model and serial number must be provided with order to ensure proper configuration).	47606394001	47606394001	47606394001	47606394001	1			
FR-1	ELEMENT, CONTROL AIR FILTER REGULATOR	15299662	15299662	15299662	15299662	1	1	1	2
FLT-2	ELEMENT, PREFILTER - HIGH EFFICIENCY	24242398	24242471	24242513	24242554	1	1	1	2
FLT-3	ELEMENT, AFTERFILTER - DUST PARTICULATE	24242380	24242463	24242505	24242547	1	1	1	2
DPI-2, DPI-3	GAUGE, DIFFERENTIAL PRESSURE, FILTER	24335051	24335051	24335051	24335051	2			
PI-1, PI-2, PI-3	GAUGE, PRESSURE, TOWER/PURGE	38053153	38052973	38052973	38052973	3			
DR-2, DR-3	INTERNAL DRAIN, FILTER	24335028	24335028	24335028	24335028	2			
EXH-1, EXH-2	MUFFLER, TOWER PURGE	38054524	38054540	38054540	38054540	2	2	2	2
	OVERLAY, DISPLAY BOARD	23540198	23540198	23540198	23540198	1			
	POWER SUPPLY	47587161001	47587161001	47587161001	47587161001	1	1	1	1
FX-1A, FX-2A	RETAINER, DESICCANT SCREEN, UPPER MANIFOLD	38054573	38054565	38054565	38054565	2			
FX-1B, FX-2B	RETAINER, DESICCANT SCREEN, LOWER MANIFOLD	38054573	38054565	38054565	38054565	2			
FV-1A, FV-2A	VALVE, TOWER INLET	47590670001	47633579001	47633579001	47633579001	2			
FV-1B, FV-2B	VALVE, TOWER PURGE	47590667001	47590669001	47590669001	47590669001	2			
HCV-1	VALVE, PURGE FLOW METERING	38054516	38054052	38054052	38054052	1			
HCV-2, HCV-3, HCV-4	VALVE, CONTROL AIR, SHUTOFF/BLEED	38054086	38054086	38054086	38054086	3			
FV-1P, FV-2P	VALVE, CHECK, TOWER PURGE	47787971003	47787971005	47787971005	47787971005	2			
FV-1C, FV-2C	VALVE, CHECK, TOWER OUTLET	38054458	38053484	38053484	38053484	2			
PSV-1, PSV-2	VALVE, SAFETY/RELIEF, TOWER	23642432	38054060	38054060	38054060	2			
FV-4A, FV-4B, FV-4C, FV-4D	VALVE, SOLENOID, CONTROL AIR	47606405001	47606405001	47606405001	47606405001	4			

NOTE 1: Refer to the Desiccant Fill Chart in this Technical Manual: SECTION 9, MAINTENANCE AND SYSTEM CHECK SPARES: Quantity recommended be kept on-hand for maintenance or repair.

CLASS 1: Minimum quantity retained - Where interruptions in service are acceptable.

CLASS 2: Average quantity retained - Where some interruptions in service are acceptable.

CLASS 3: Maximum quantity retained - Where interruptions in service are unacceptable.

FLOW DIAGRAM REFERENCE	DESCRIPTION	HLA1500 1H00AA	HLA1800 1H00AL	HLA2100 1H00AL	HLA2700 1H00AL	"QTY/ UNIT"	SPARES		
							1	2	3
MI-4	BLUE MOISTURE INDICATOR (BMI)	38054284	38054284	38054284	38054284	1			
	DESICCANT	NOTE 1	NOTE 1	NOTE 1	NOTE 1	NOTE 1			
	DISPLAY BOARD, PANEL	38053682	38053682	38053682	38053682	1			
	DRYER CONTROLLER TYPE 4 WITH DESICCANT PROGRAM (Dryer model and serial number must be provided with order to ensure proper configuration).	47606394001	47606394001	47606394001	47606394001	1			
FR-1	ELEMENT, CONTROL AIR FILTER REGULATOR	15299662	15299662	15299662	15299662	1	1	1	2
FLT-2	ELEMENT, PREFILTER - HIGH EFFICIENCY	24242596 (1)	38446357 (3)	38446357 (4)	38446357 (5)	(Multiple)	1 Set	1 Set	2 Sets
FLT-3	ELEMENT, AFTERFILTER - DUST PARTICULATE	24242588 (1)	23553357 (3)	23553357 (4)	23553357 (5)	(Multiple)	1 Set	1 Set	2 Sets
DPI-2, DPI-3	GAUGE, DIFFERENTIAL PRESSURE, FILTER	24335051	38458402	38458402	38458402	2			
PI-1, PI-2, PI-3	GAUGE, PRESSURE, TOWER/PURGE	38052973	38052973	38052973	38052973	3			
DR-2, DR-3	INTERNAL DRAIN, FILTER	24335028	-	-	-	2			
EXH-1, EXH-2	MUFFLER, TOWER PURGE	38054045	38054045	38054045	38054045	2	2	2	2
	OVERLAY, DISPLAY BOARD	23540198	23540198	23540198	23540198	1			
	POWER SUPPLY	47587161001	47587161001	47587161001	47587161001	1	1	1	1
FX-1A, FX-2A	RETAINER, DESICCANT SCREEN, UPPER MANIFOLD	38054292	38054326	38054326	38054326	2			
FX-1B, FX-2B	RETAINER, DESICCANT SCREEN, LOWER MANIFOLD	38054292	38054326	38054326	38054326	2			
FV-1A, FV-2A	VALVE, TOWER INLET	47633580001	47633580001	47633580001	47633580001	2			
FV-1B, FV-2B	VALVE, TOWER PURGE	47590672001	47590672001	47590672001	47590672001	2			
HCV-1	VALVE, PURGE FLOW METERING	38054052	38054052	38054052	38054532	1			
HCV-2, HCV-3, HCV-4	VALVE, CONTROL AIR, SHUTOFF/BLEED	38054086	38054086	38054086	38054086	3			
FV-1P, FV-2P	VALVE, CHECK, TOWER PURGE	47787971005	47787971005	47787971005	47787971006	2			
FV-1C, FV-2C	VALVE, CHECK, TOWER OUTLET	38053484	38053484	38053484	38053567	2			
PSV-1, PSV-2	VALVE, SAFETY/RELIEF, TOWER	38054060	38054375	38054375	38054375	2			
FV-4A, FV-4B, FV-4C, FV-4D	VALVE, SOLENOID, CONTROL AIR	47606405001	47606405001	47606405001	47606405001	4			

NOTE 1: Refer to the Desiccant Fill Chart in this Technical Manual: SECTION 9, MAINTENANCE AND SYSTEM CHECK SPARES: Quantity recommended be kept on-hand for maintenance or repair.

CLASS 1: Minimum quantity retained - Where interruptions in service are acceptable.

CLASS 2: Average quantity retained - Where some interruptions in service are acceptable.

CLASS 3: Maximum quantity retained - Where interruptions in service are unacceptable.

FLOW DIAGRAM REFERENCE	DESCRIPTION	HLA3300 1H00AL	HLA4000 1H00AL	HLA5000 1H00AL	"QTY/ UNIT"	SPARES		
						1	2	3
MI-4	BLUE MOISTURE INDICATOR (BMI)	38054284	38054284	38054284	1			
	DESICCANT	NOTE 1	NOTE 1	NOTE 1	NOTE 1			
	DISPLAY BOARD, PANEL	38053682	38053682	38053682	1			
	DRYER CONTROLLER TYPE 4 WITH DESICCANT PROGRAM (Dryer model and serial number must be provided with order to ensure proper configuration).	47606394001	47606394001	47606394001	1			
FR-1	ELEMENT, CONTROL AIR FILTER REGULATOR	15299662	15299662	15299662	1	1	1	2
FLT-2	ELEMENT, PREFILTER - HIGH EFFICIENCY	38446357 (6)	38446357 (7)	38446357 (10)	(Multiple)	1 Set	1 Set	2 Sets
FLT-3	ELEMENT, AFTERFILTER - DUST PARTICULATE	23553357 (6)	23553357 (7)	23553357 (10)	(Multiple)	1 Set	1 Set	2 Sets
DPI-2, DPI-3	GAUGE, DIFFERENTIAL PRESSURE, FILTER	38458402	38458402	38458402	2			
PI-1, PI-2, PI-3	GAUGE, PRESSURE, TOWER/PURGE	38052973	38052973	38052973	3			
DR-2, DR-3	INTERNAL DRAIN, FILTER	-	-	-	2			
EXH-1, EXH-2	MUFFLER, TOWER PURGE	38054045	38054045	38054045	4	4	4	4
	OVERLAY, DISPLAY BOARD	23540198	23540198	23540198	1			
	POWER SUPPLY	47587161001	47587161001	47587161001	1	1	1	1
FX-1A, FX-2A	RETAINER, DESICCANT SCREEN, UPPER MANIFOLD	38054300	38054300	38054334	2			
FX-1B, FX-2B	RETAINER, DESICCANT SCREEN, LOWER MANIFOLD	38054300	38054300	38054334	2			
FV-1A, FV-2A	VALVE, TOWER INLET	47633581001	47633581001	47633581001	2			
FV-1B, FV-2B	VALVE, TOWER PURGE	47633579001	47633579001	47633579001	2			
HCV-1	VALVE, PURGE FLOW METERING	38054532	38054532	38054532	1			
HCV-2, HCV-3, HCV-4	VALVE, CONTROL AIR, SHUTOFF/BLEED	38054086	38054086	38054086	3			
FV-1P, FV-2P	VALVE, CHECK, TOWER PURGE	47787971006	47787971006	23557945	2			
FV-1C, FV-2C	VALVE, CHECK, TOWER OUTLET	38053567	38053567	38053575	2			
PSV-1, PSV-2	VALVE, SAFETY/RELIEF, TOWER	38054375	38054375	38054375	2			
FV-4A, FV-4B, FV-4C, FV-4D	VALVE, SOLENOID, CONTROL AIR	47606405001	47606405001	47606405001	4			

NOTE 1: Refer to the Desiccant Fill Chart in this Technical Manual: SECTION 9, MAINTENANCE AND SYSTEM CHECK SPARES: Quantity recommended be kept on-hand for maintenance or repair.

CLASS 1: Minimum quantity retained - Where interruptions in service are acceptable.

CLASS 2: Average quantity retained - Where some interruptions in service are acceptable.

CLASS 3: Maximum quantity retained - Where interruptions in service are unacceptable.

ANGLE VALVE REBUILD PARTS

VALVE PART NUMBER	VALVE DESCRIPTION	REPLACEMENT ACTUATOR PART NUMBER (CALLOUT 1)	SEAL REBUILD KIT* PART NUMBER (CALLOUT 2)	MOUNTING TOOLS PART NUMBER
47590665001	VALVE, ANGLE, 3/4" P.O.N.C.	47607077001	47607078001	47607080001
47590664001	VALVE, ANGLE, 3/4" P.O.N.O.	47607077002	47607078002	
47590667001	VALVE, ANGLE, 1" P.O.N.C.	47607077003	47607078003	47607080001
47590666001	VALVE, ANGLE, 1" P.O.N.O.	47607077004	47607078004	
47590669001	VALVE, ANGLE, 1-1/2" P.O.N.C.	47607077005	47607078005	47607080002
47590668001	VALVE, ANGLE, 1-1/2" P.O.N.O.	47607077006	47607078006	
47590672001	VALVE, ANGLE, 2" P.O.N.C.	47607077007	47607078007	47607080002
47590670001	VALVE, ANGLE, 2" P.O.N.O.	47607077008	47607078008	
47590671001	VALVE, ANGLE, 2" P.O.N.O.	47607077009	47607078009	

*Seal Rebuild Kit includes: Seat Seal, Head Section Seal, Exterior Lip Seal

Mounting tool is required for normally-closed valves (P.O.N.C.) only. Tool is required to decompress springs and is required for safe dismantling of the valve.

Tool is needed to install Replacement Actuator, as well as to install Seal Rebuild kit.

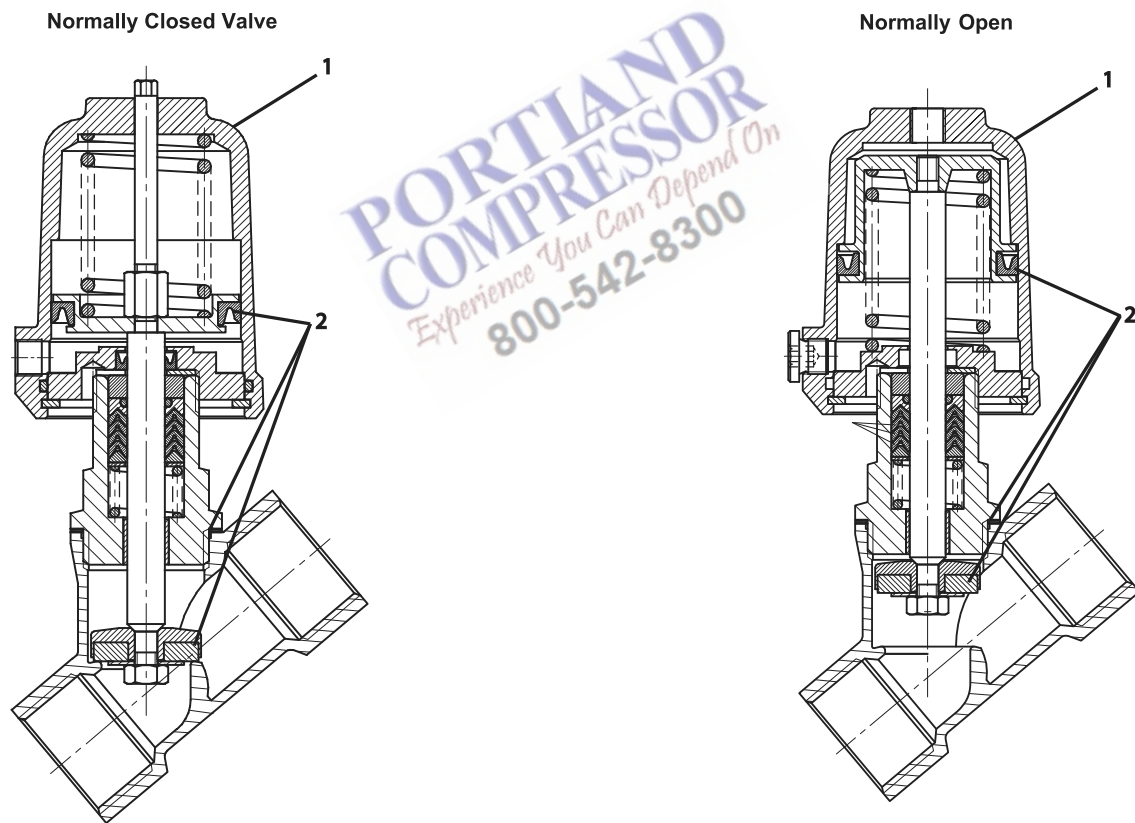

■ HIGH PERFORMANCE BUTTERFLY VALVE DETAIL VIEWS

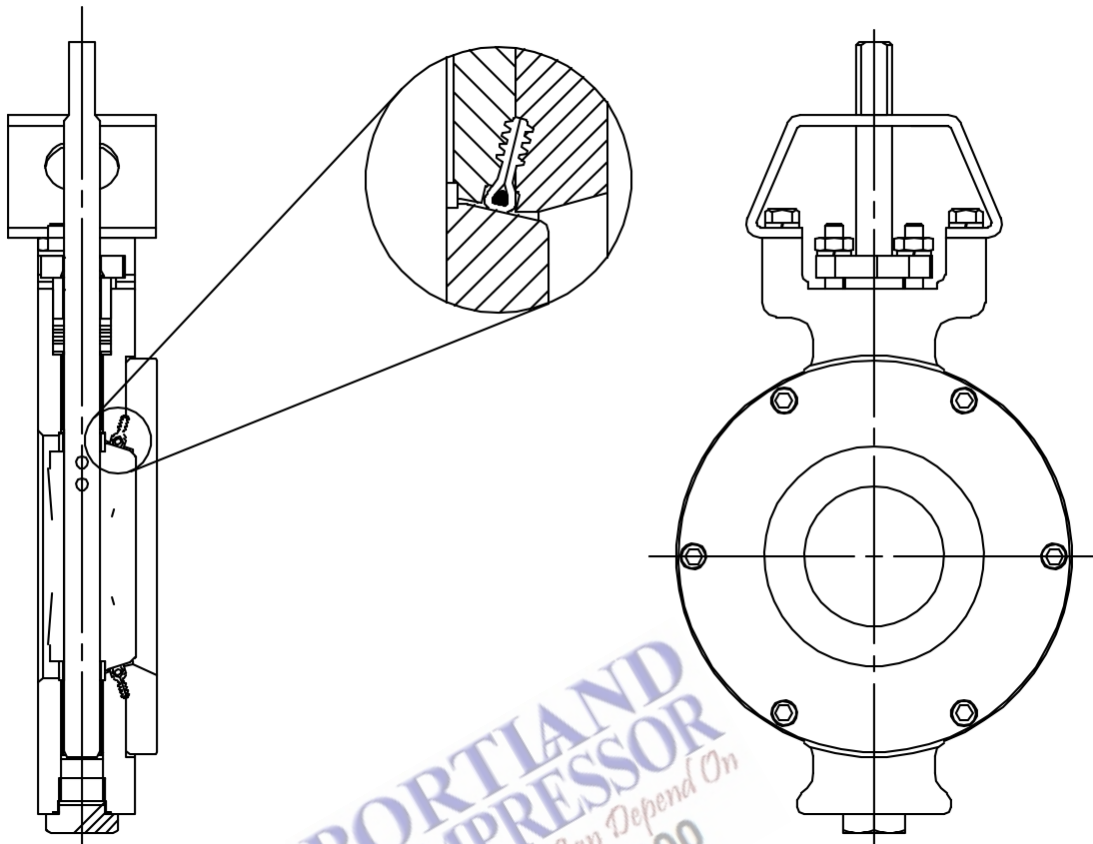

NOTE: Actuator not shown for clarity.

PORTLAND COMPRESSOR
Experience You Can Depend On
 800-542-8300

VALVE PART NUMBER	VALVE DESCRIPTION	REPLACEMENT VALVE W/ GASKETS PART NUMBER	SEAL REBUILD KIT PART NUMBER*
47595375001	VALVE BUTTERFLY 3" W/ ACTUATOR	47633579001	47633604001
47595376001	VALVE BUTTERFLY 4" W/ ACTUATOR	47633580001	47633605001
47595377001	VALVE BUTTERFLY 6" W/ ACTUATOR	47633581001	47633606001

* Seal Rebuild Kit includes new valve seat and stem seals.

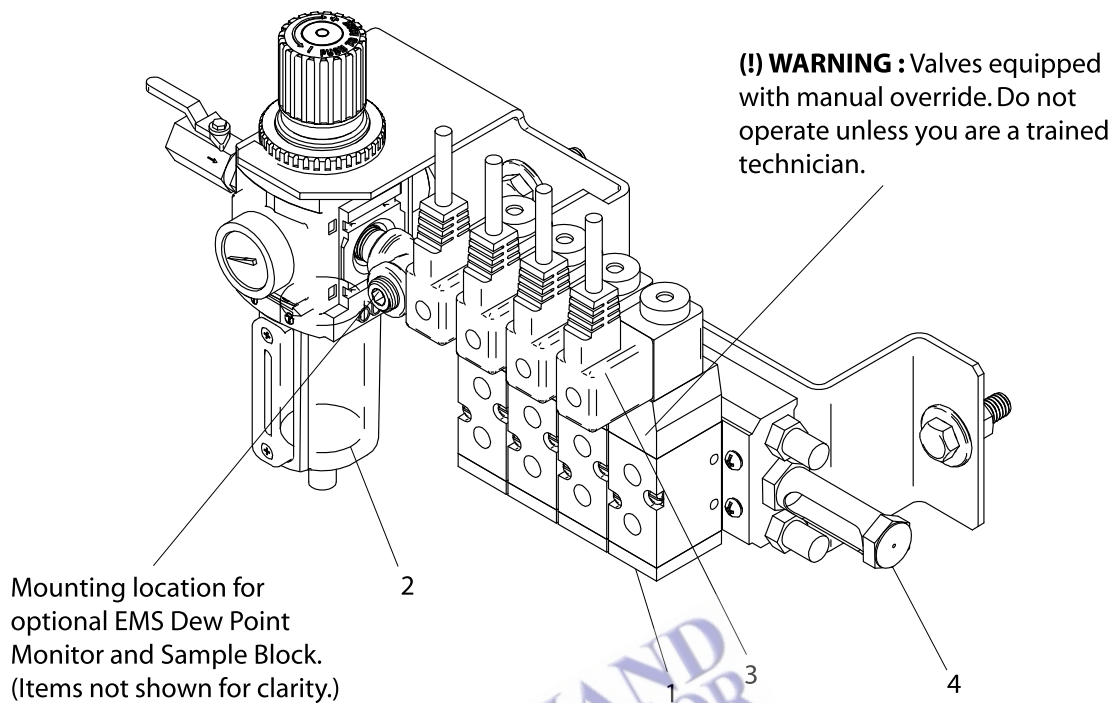

ITEM NO.	PART NO.	DESCRIPTION
1	47606405001	Solenoid Valve with Gasket and Mounting Hardware (Individual valve)
2	104422	Filter Regulator Element
3	81322547	DIN Connector, Solenoid Valve, right angle, with Gasket and Cord
4	705001-SP	Blue Moisture Indicator

EMS REPLACEMENT PARTS

VALVE PART	VALVE DESCRIPTION
CABLE, TRANSMITTER	633671
RESISTOR, 250 OHM (R3 on wiring diagram)	23134851
TRANSMITTER, DEWPOINT (MIC-1 on flow digram)	23167778

4-20 mA Dew Point Signal Current Loop Repeater Spare Part Table	
Description	Replacement Part
REPEATER, CURRENT LOOP 4-20mA	23174022

3V Bypass & Filter Package Valve Replacement Part Table	
Description	Part Number
VALVE, BALL 1"	38054037
VALVE, BALL 1-1/2"	38054052
VALVE, BALL 2"	38054532
VALVE, BUTTERFLY 3", WAFER STYLE	23456031
VALVE, BUTTERFLY 4", WAFER STYLE	23456049
VALVE, BUTTERFLY 6", WAFER STYLE	23456056

16.0ENGINEERING SPECIFICATIONS

MODEL	Inlet Flow -40 Dew point SCFM	Inlet Flow -100 Dew point SCFM	Purge Flow (m3/h)	Width in. (cm)	Depth in. w/o Bypass (cm)	Depth in. w/ Bypass (cm)	Height in (cm)	Air In & Out Conne- ction	Shipping Weight lbs (kg)	Desiccant Weight per Dryer (kg)
HLA90	90	72	14	40.5 (102.9)	30 (76.2)	37.5 (95.3)	63.12 (160.3)	1	475 (213)	100 (45)
HLA120	120	96	19	40.5 (102.9)	30 (76.2)	37.5 (95.3)	63.12 (160.3)	1	563 (255)	134 (61)
HLA160	160	128	26	44.5 (113)	32 (81.3)	43.75 (111.1)	66.12 (167.9)	1 1/2	707 (321)	192 (87)
HLA200	200	160	30	44.5 (113)	32 (81.3)	43.75 (111.1)	66.12 (167.9)	1 1/2	731 (332)	236 (107)
HLA250	250	200	40	48.5 (123.2)	32 (81.3)	44.19 (112.2)	66.81 (169.7)	1 1/2	869 (394)	290 (132)
HLA300	300	240	48	48.5 (123.2)	32 (81.3)	50.38 (128.0)	66.81 (169.7)	2	924 (419)	344 (156)
HLA400	400	320	65	52.5 (133.4)	36.19 (91.9)	50.94 (129.4)	67.81 (172.2)	2	1115 (506)	470 (213)
HLA500	500	400	81	56.5 (143.5)	39.69 (100.8)	54.5 (138.4)	82.5 (209.6)	2	1564 (709)	638 (289)
HLA600	600	480	93	56.5 (143.5)	42.4 (107.8)	57.25 (145.4)	82.5 (209.6)	2	1664 (755)	748 (339)
HLA800	800	640	130	64 (162.6)	51.25 (130.2)	64.38 (163.5)	87.62 (222.6)	3	2017 (915)	900 (408)
HLA1000	1000	800	162	64 (162.6)	51.25 (130.2)	64.38 (163.5)	87.62 (222.6)	3	2237 (1015)	1100 (499)
HLA1200	1200	960	195	64 (162.6)	51.25 (130.2)	64.38 (163.5)	87.62 (222.6)	3	2424 (1100)	1270 (576)
HLA1500	1500	1200	243	78 (198.1)	54.76 (139.1)	N/A	80 (203.2)	4	2974 (1349)	1600 (726)
HLA1800	1800	1440	292	84 (213.4)	60.62 (154.0)	N/A	91.88 (233.4)	4	3905 (1771)	2000 (907)
HLA2100	2100	1680	340	84 (213.4)	60.62 (154.0)	N/A	91.88 (233.4)	4	4279 (1941)	2340 (1062)
HLA2700	2700	2160	438	84 (213.4)	60.76 (154.3)	N/A	91.88 (233.4)	4	4926 (2234)	2928 (1328)
HLA3300	3300	2640	535	96 (244)	66 (167.6)	N/A	100 (254)	6	2950 (1338)	4000 (1814) *
HLA4000	4000	3200	649	96 (244)	66 (167.6)	N/A	100 (254)	6	3000 (1361)	4400 (1996) *
HLA5000	5000	4000	811	102 (259)	72 (183)	N/A	92 (233.7)	6	3950 (1792)	5600 (2540) *

* Dryer weight shown does not include desiccant. Desiccant shipped separately.

Note: All above dryers rated at 150 psig, 120 °F max inlet temperature.

Capacity and purge flow is basis standard inlet conditions (100 psig / 100 °F) and will vary at different inlet conditions.

NOTICE

Specification information above accurate at time of publication. Refer to equipment serial label for actual specifications for units.



**PORTLAND
COMPRESSOR**
Experience You Can Depend On
800-542-8300

**PORTLAND
COMPRESSOR**
Experience You Can Depend On
800-542-8300